

Élite Kitchen

elleci
TOGETHER, WITH STYLE

Index

Together, with Style	4	Lavelli	24
Elleci District	6	Sinks	
Élite Kitchen	8	Mixology	26
Keratek	10	Dialogo	50
Colours	12	Sintesi	66
Installations	14	Zen	96
Workstation	16	Integra	110
Mix & Match	18	Essenza	126
Drain System	20	Miscelatori	132
Family Feeling	22	Taps	
		Elettrodomestici	158
		Built-in Appliances	
		Piani cottura	172
		Hobs	

Together, with Style

Elleci è una **storia collettiva**, che unisce spirito imprenditoriale, talenti individuali e sogni condivisi in un progetto ambizioso: la connessione tra progresso tecnologico e valori umanistici. Una vision forte e inconfondibile, che pone le **persone al centro** nella creazione di ogni prodotto: nasce uno **stile unico**, interpretazione moderna della sensibilità al **bello, utile e piacevole**.

Elleci is a **collective story**, one that brings together entrepreneurial spirit, individual talents and shared dreams in an ambitious project: the connection between technological progress and humanistic values. A strong and unmistakable vision, **focused on people** in the creation of every product: resulting in a **unique style**, a modern interpretation of sensitivity to everything that is **beautiful, useful and attractive**.



elleci district

Un hub tecnologico e menti appassionate A high tech hub and passionate minds

UNO SPAZIO CHE CRESCE PER IDEE IN CONTINUA EVOLUZIONE

Da più di trent'anni creiamo materiali innovativi e diamo forma a soluzioni di design che migliorano la qualità della vita delle persone.

Combiniamo tecnologia, stile italiano e una preziosa capacità di anticipare i desideri per elevare le esperienze di tutti i giorni in cucina e in bagno.

A GROWING SPACE FOR CONSTANTLY EVOLVING IDEAS

For more than 30 years we have been creating innovative materials and shaping design solutions that improve people's quality of life.

We combine technology, Italian style and matchless ability to anticipate desires to elevate everyday experiences in the kitchen and bathroom.

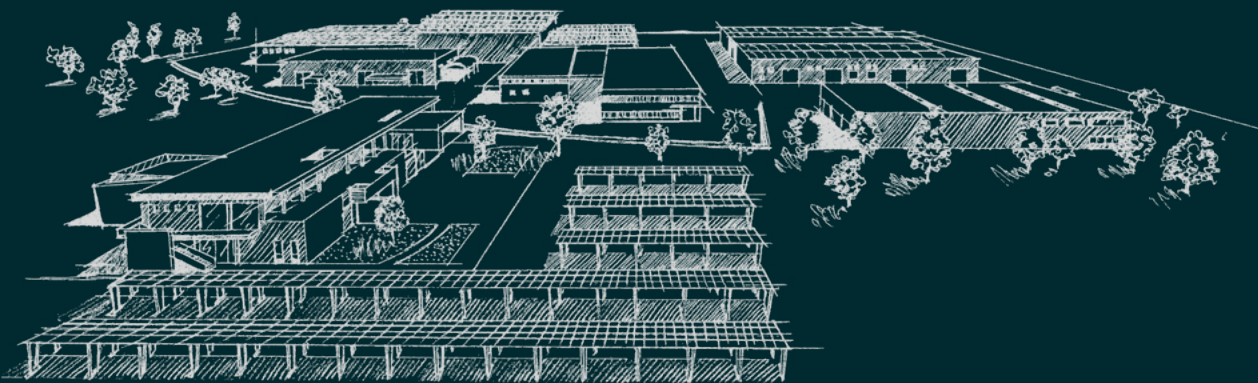

elleci plant 1

Impianto produttivo storico incentrato sulla flessibilità e customizzazione della produzione.

Historic manufacturing plant focused on flexibility and customization of production.

elleci plant 2

Impianto produttivo indipendente, altamente sostenibile e tecnologico in cui tradizione e know how incontrano modernità e automazione.

Independent, highly sustainable and technological production plant where tradition and know-how meet modernity and automation.

elleci innovation center

Dedicato alla ricerca e sviluppo dove le idee più ambiziose prendono forma.

Dedicated to research and development where the most ambitious ideas take shape.

elleci care

Valore e cura delle relazioni: questo spazio è completamente indirizzato a rafforzare il rapporto di fiducia con i clienti nelle fasi di pre e post vendita.

Value and caring relationships: this space is fully directed at enhancing the relationship of trust with customers in pre- and post-sales phases.

elleci home

Un'area di accoglienza e formazione; un luogo dove far convivere passato e visioni future. Un'esperienza completa del mondo Elleci.

A hospitality and training area; a place where past and future visions coexist. A complete experience of Elleci world.

100.000mq

Area totale
Total Area

50.000mq

Area di produzione
Production area

1,2 Milioni unità/anno
Million units/year

Capacità produttiva
Production capacity

ESG Program

IL NOSTRO IMPEGNO QUOTIDIANO PER UN MONDO MIGLIORE.

Oggi, più che mai, innovazione vuol dire responsabilità. Poggiamo ogni scelta aziendale su obiettivi concreti:

- Programma "Road to 2030-2050"
- Catena di fornitura sostenibile
- Investire nei talenti e nel territorio
- Governance aziendale trasparente e solida

OUR DAILY COMMITMENT TO A BETTER WORLD.

Today, more than ever, innovation means responsibility. We base every business decision on fixed goals:

- Program "Road to 2030-2050"
- Sustainable supply chain
- Believe in talents and territory
- Transparent financial governance

Green attitude

50%

Energia da fonti rinnovabili
Energy self-sufficiency

2,1MW

Sistema fotovoltaico
Photovoltaic system

Riciclo dell'acqua
nel processo produttivo a circuito chiuso
Water recycling
in the closed-loop production process



Gestione dei rifiuti ed
economia circolare
Waste management
& circular economy



Imballaggi sostenibili
100% riciclati e riciclabili
Sustainable packaging
100% recycled and recyclable



Élite Kitchen

Forma, materia e sensi: il nuovo paradigma dello stile disegnato da Elleci

Élite Kitchen ridefinisce l'ambiente cucina con soluzioni uomo-spazio innovative e affascinanti e ispira le tendenze della progettazione d'interni. Materiali esclusivi, design intelligente e ricerca estetica si combinano in un processo di nobilitazione del prodotto, che pervade ogni dettaglio.

Protagonista della linea premium il Keratek: la materia sublima l'esperienza visiva e tattile; la bellezza dei lavelli in composito si declina in una tavola cromatica intensa, che diviene ancor più preziosa nel "mix & match" con superfici e finiture, secondo i desideri di ognuno.

Accessori evoluti e la potenza dell'ergonomia elevano l'area lavaggio a originale concetto di workstation per raggiungere la massima espressione in Mixology. Tecnologia e family feeling plasmano le collezioni di miscelatori dalla personalità ricercata e di elettrodomestici matt black, inaugurando un set performante dove mettere in scena ogni giorno passione e creatività.

Élite Kitchen è la nuova promessa del lusso domestico, che celebra lo stile individuale e il piacere della convivialità.

Shape, materials and senses: the new style formula designed by Elleci

Élite Kitchen revamps the kitchen environment with innovative and attractive people-space solutions, inspiring trends in interior design. Exclusive materials, smart design and elegance are combined in a process of enhancing the product that is imbued in every detail.

Keratek is the star of the premium range: the material is visually attractive and a joy to touch; the beauty of composite sinks is showcased in an intense colour palette enhanced by "mix & match" options of surfaces and finishes, ensuring a personalised result.

State-of-the-art accessories and the power of ergonomics transform the washing area into an innovative workstation concept, showcasing the concept of Mixology. Technology and a family feeling shape the collections of elegant mixer taps and matt black appliances, creating a high-performance setting in which passion and creativity take centrality in the everyday stage.

Élite Kitchen is the new promise of domestic luxury, celebrating individual style and the pleasure of spending time with friends and family.

KERATEK

Prezioso in ogni nanoparticella

Every nanoparticle counts

Il materiale premium creato per elevare l'esperienza sensoriale quotidiana in cucina

La materia ultracompatta, plasmata attraverso la nanotecnologia, è qui.

L'innovativa formula con quarzo, microceramiche e un mix di resine acriliche rivoluziona gli standard di bellezza e performance dei lavelli in composito: il colore opaco, intenso e profondo non ha eguali; la superficie a zero porosità è resistente e ultrasliscia per un look and feel elegante e moderno.

The premium material created to heighten the sensory experience of everyday life in the kitchen

Introducing the ultra-compact material shaped by nanotechnology.

The innovative formula with quartz, micro-ceramics and a blend of acrylic resins revolutionises the standards of beauty and performance of composite sinks: the deep, intense, matt colour is unrivalled; the non-porous surface is resistant and ultra-smooth for an elegant modern look and feel.

Caratteristiche / Features

Finitura setosa al tatto
Silky smooth finish



Un prezioso effetto seta che seduce al tatto
An attractive, silky feel

Colore intenso
Intense colour



La potenza cromatica vince ogni sfida del tempo
The durable colour is a timeless winner

Facile da pulire
Easy to clean



La superficie ultracompatta assicura la massima igienicità
The ultra-compact surface ensures maximum hygiene

Resistente agli urti
Impact resistant



La superficie robusta resta indenne agli urti
The hard-wearing surface withstands impact

Resistente all'acqua bollente istantanea
Instant hot water resistant



Idoneo a sistemi che erogano acqua bollente istantanea
appropriate for systems delivering instantaneous boiling water

Fatto per durare
Made to last



Creato per non subire gli effetti dell'usura
Designed to challenge wear and tear



Keratek è certificato da NSF come materiale altamente igienico

Keratek is certified by NSF as a highly hygienic material



Prodotto certificato per basse emissioni chimiche UL.com/gg ul 2818

Product certified for low chemical emissions UL.com/gg ul 2818

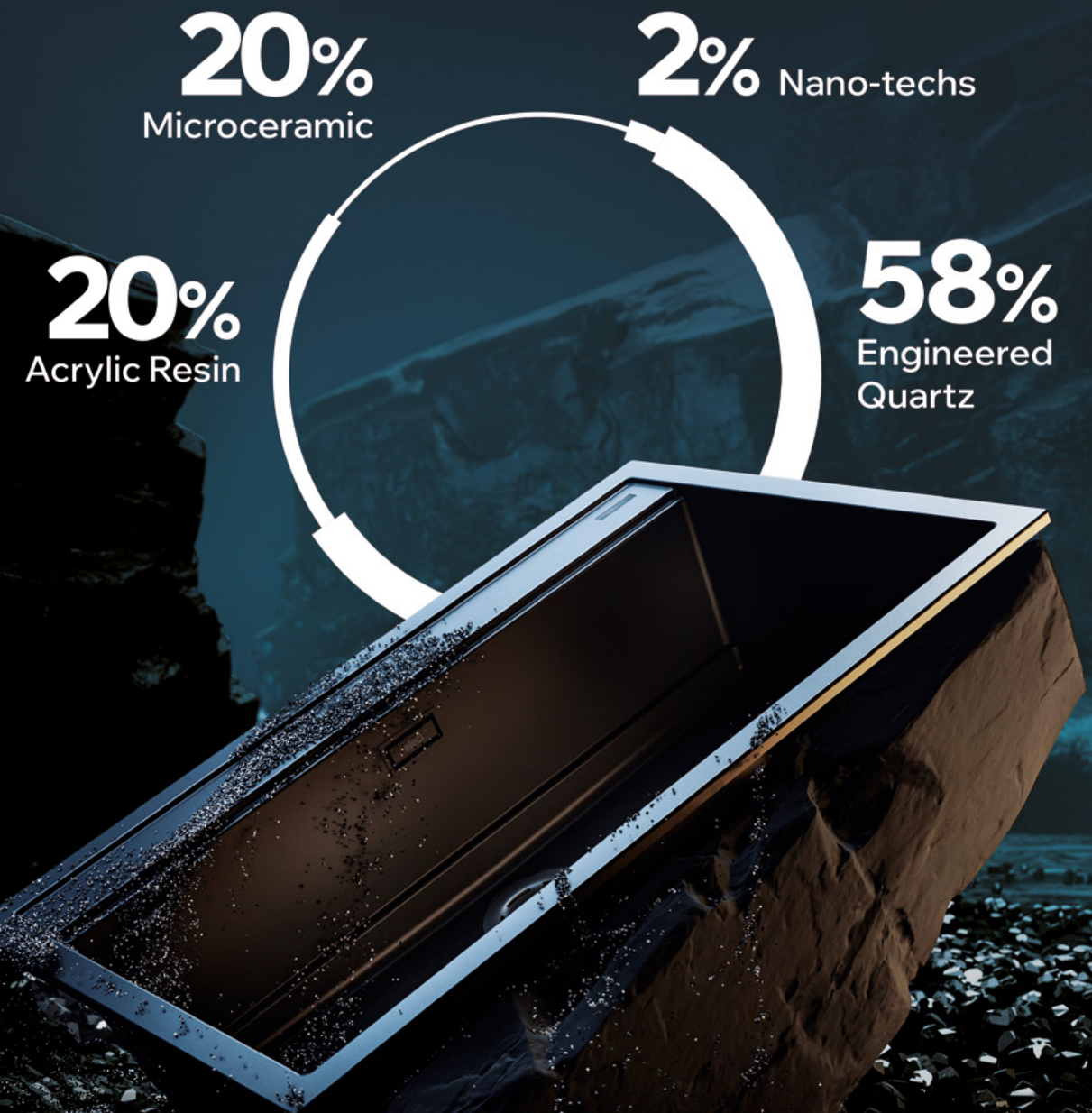

Finitura setosa al tatto
Silky smooth finish



Colore intenso
Intense colour



Facile da pulire
Easy to clean



Resistente agli urti
Impact resistant



Resistente all'acqua bollente istantanea
Instant hot water resistant



Fatto per durare
Made to last

KERATEK

Colours



Fascino supremo

Il Keratek si distingue per l'anima strutturale piena, densa e vivida e la superficie estremamente liscia che rivela la fusione di materia e colore in sei nuance di tendenza: Black, Dark Grey, White, Clay, Sage e Cocoa.

Supreme charm

The hallmark feature of Keratek is its solid, dense, vivid composition and ultra-smooth surface that reveals the fusion of material and colour in six trendy shades: Black, Dark Grey, White, Clay, Sage and Cocoa.

Installations

Integra

Il particolare bordo di Integra, rettificato a raggio zero, consente la perfetta giunzione con il piano di lavoro appositamente preparato per l'integrazione, creando una vera e propria fusione tra i due materiali.



Essenza

La soluzione monolitica per vasche realizzate nello stesso materiale del piano di lavoro. Essenza è il fondo vasca con angoli interni raggianti, progettato per garantire una migliore praticità di pulizia e una performance di eccellenza nell'area più stressata di utilizzo.

The monolithic solution for sinks made of the same material as the work top. Essenza is the sink bottom with rounded inner corners, designed to guarantee an improved cleaning easiness as well as excellent performance in the most stressed area of use.

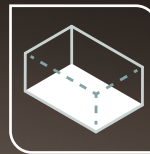

3 sistemi, una scelta di valore 3 systems, one value choice

Le collezioni di lavelli Mixology, Dialogo, Sintesi e Zen possono essere configurate in diversi sistemi di installazione a seconda del proprio gusto estetico e funzionale. Ogni tipo di prodotto dispone delle sue varianti, ciascuna di esse differisce per caratteristiche tecniche e di lavorazione del piano, ma tutte sono accomunate da un valore di design unico e inconfondibile.

Mixology, Dialogo, Sintesi and Zen sink collections can be configured in different installation systems depending on your aesthetic and functional taste. All the products come with their own variations, each of which has different technical features and worktop installations, but all sharing a unique and unmistakable design value.

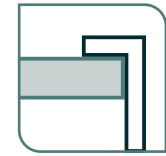

Sopratop Inset

- × Mixology
- × Dialogo
- × Sintesi
- × Zen



Sottotop Undermount

- × Dialogo
- × Zen

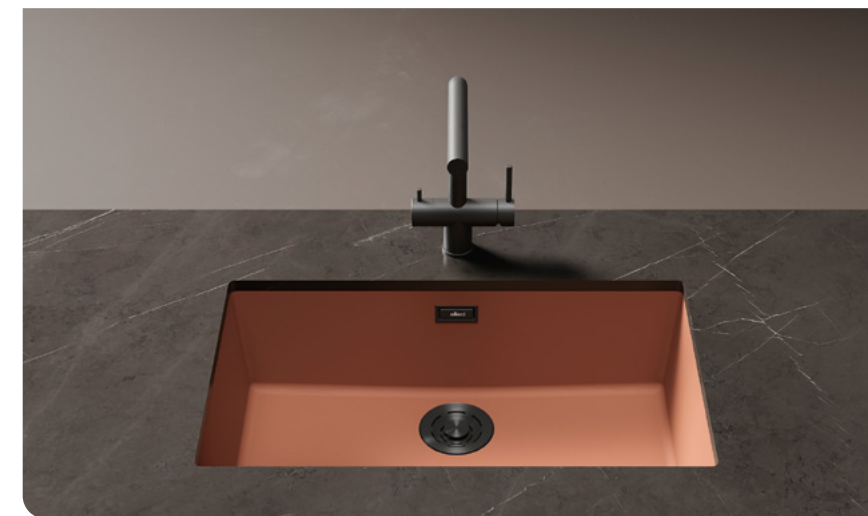

Filotop Flushmount

- × Mixology
- × Sintesi
- × Zen F

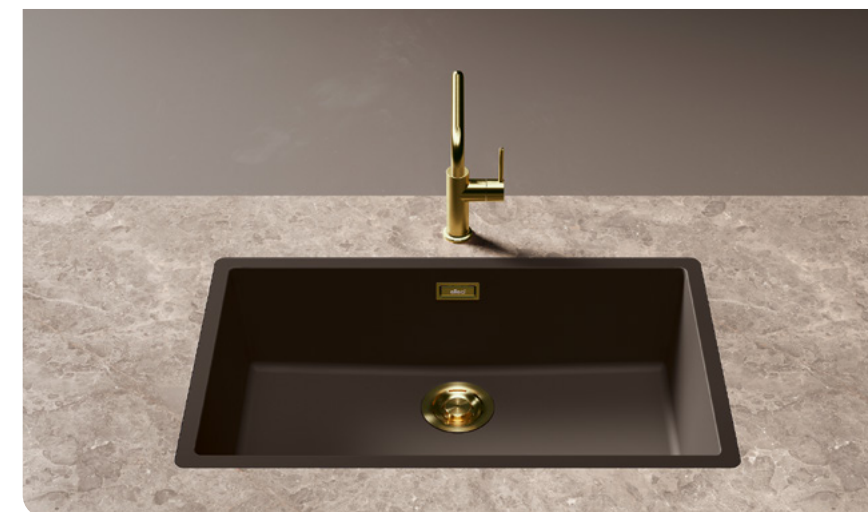

Workstation

Una postazione all-in-one

Il design del prodotto progetta gli spazi secondo principi di ergonomia e funzionalità: geometrie razionali e differenti livelli di lavoro interagiscono con una molteplicità di accessori, che semplificano ogni gesto ed elevano il piacere della preparazione.

All-in-one workstation

The product is designed to use spaces through ergonomics and functionality: rational shapes and multiple work levels interact with a whole host of accessories to make life easy in the kitchen and food preparation enjoyable.

Mix & Match

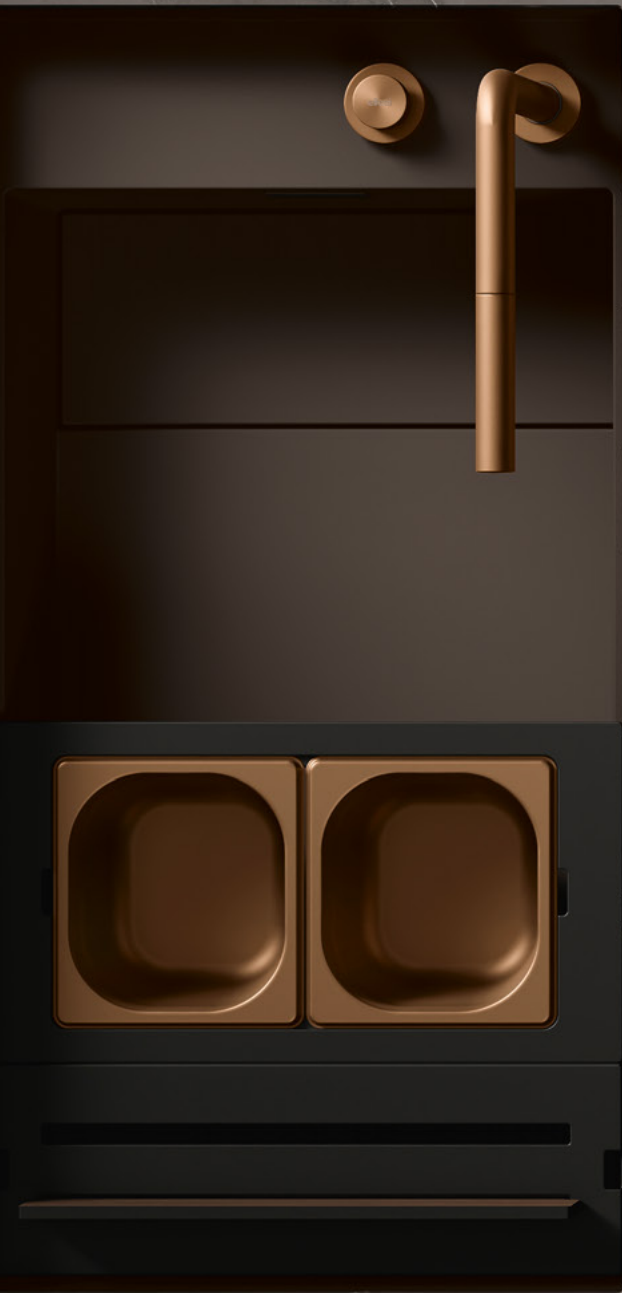

BRONZE

Finiture preziose

Black, Gold, Bronze e Inox Spazzolato: quattro finiture valorizzano le forme estetiche di componenti, miscelatori e accessori e si abbinano a particolari di stile dell'ambiente. Per vivere la cucina come continuum della casa e della propria personalità.

Elegant finishes

Black, Gold, Bronze and Brushed Stainless Steel: four finishes highlighting the visual appearance of components, mixers taps and accessories, while complementing the style details of the room. Allowing you to enjoy the kitchen as an extension of your home and your personality.



BLACK

GOLD

INOX

Drain System

Il sistema di scarico moderno:
bello, efficiente, pratico nell'utilizzo
e nella manutenzione

The modern drain system:
attractive, efficient, easy to use
and maintain

Open Up

Il comando remoto
push-control
dall'estetica flat
e minimal chic.

The push-control
remote control with a
flat, minimal chic look.



Open Twist

Il comando remoto
rotativo dall'elegante
superficie godronata.

The twist remote
control with an elegant,
textured surface.

Flow Pro

Flow Pro è l'innovativo sistema di scarico della
linea Élite Kitchen, che diventa un dettaglio di stile.

Flow Pro is the innovative drain system for
Élite Kitchen, transformed into a style detail.

Il design è estetica funzionale
Design is functional aesthetic

Flow Pro

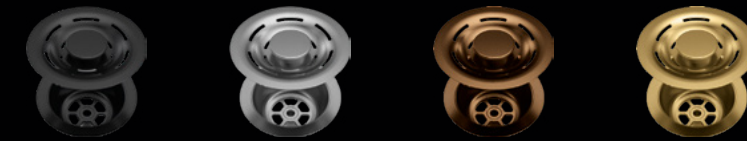

La soluzione esclusiva Elleci è studiata per
offrire la massima funzionalità e disegnata
per garantire continuità estetica all'interno
della vasca. La scelta della finitura - Black,
Gold, Bronze e Inox Spazzolato - ne fa
un elemento di design che dialoga con
componenti ricercati.

Elleci's exclusive solution is designed to
provide maximum functionality and to fit
seamlessly in with the sink.
The choice of finish - Black, Gold, Bronze
and Brushed Stainless Steel - transforms
it into a design element that blends in with
elegant components.

Open Up



Open Twist

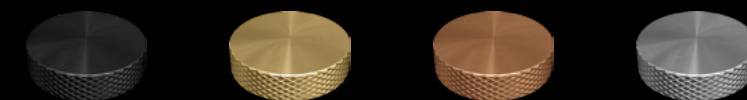

Il comando remoto, impreziosisce il lavello
e migliora ulteriormente l'esperienza di
utilizzo permettendo il controllo a distanza
di apertura e chiusura dello scarico.

The remote control, adds value to
the sink and improves its use, with
remote-controlled opening and closing of
the plug.

Family Feeling

Materica, potente e matt black

La nuova armonia cromatica in cucina

Linee estetiche essenziali e affascinanti superfici nere e opache esaudiscono i dettami dell'interior design contemporaneo più raffinato. Ogni dettaglio è pensato per integrarsi in total look con gli altri elementi dell'ambiente Kitchen, in una family line che unisce lavelli, miscelatori, accessori, piani cottura ed elettrodomestici di ultima generazione.

Materic, powerful and matt black

The new color harmony in the kitchen

Pure aesthetic lines and alluring matt black surfaces tick all the boxes for the most refined contemporary interior design. Every detail is designed to integrate into the total look with the other elements of the Kitchen, in a family line that combines sinks, mixer taps, accessories and latest generation appliances.

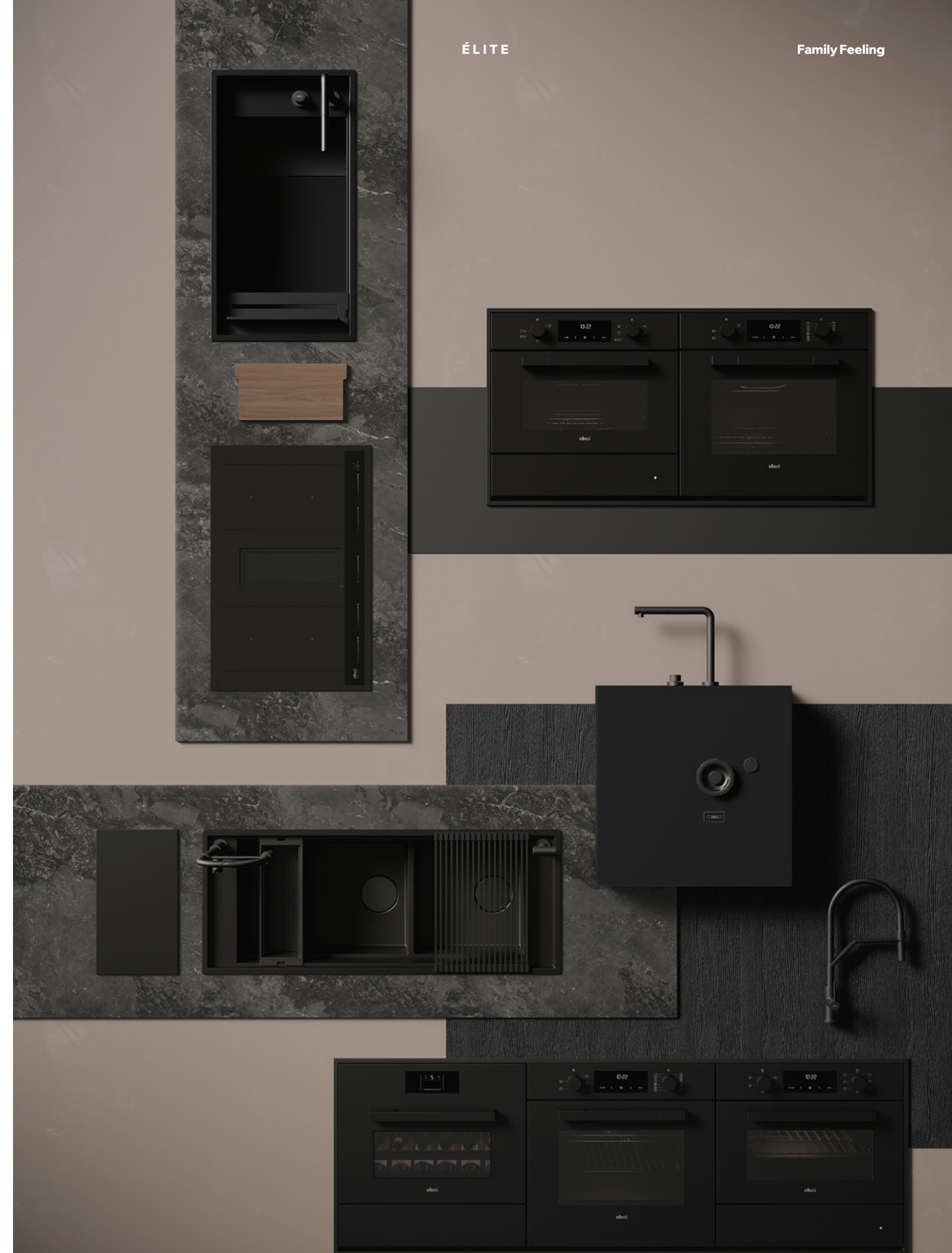

Lavelli Sinks

Mixology
K86 BLACK



Zen
K87 COCOA



Sintesi
K96 WHITE



Sintesi
K82 SAGE



Dialogo
K83 CLAY



Integra
K99 DARK GREY



Essenza
K86 BLACK



Mixology



Doppia anima

Universi che s'incontrano e si mescolano creando nuove sinergie. Mixology è l'hyper workstation pensata per unire due mondi differenti, vicini e complementari: la cucina e il bartending. Un prodotto rivoluzionario, che raccoglie gli input evolutivi del design più innovativo per vivere gli spazi conviviali in maniera inedita e felice, dalle abitazioni private ai locali d'intrattenimento sino agli avanguardistici progetti residenziali di co-living e co-housing.

Double soul

Universes that meet and blend to create new synergies. Mixology is the hyper workstation designed to combine two worlds that are different, yet similar and complementary: the kitchen and bartending. A revolutionary solution that incorporates the latest innovative design concepts, transforming social spaces into fun-filled, eye-catching environments, suitable for both private homes and entertainment spaces, as well as cutting-edge residential co-living and co-housing projects.

Mixology

BLACK



Forno microonde / Microwave oven **Sipario**
Cantina / Wine cellar **Sipario**



Piano induzione 30 / Induction hob 30 **Sipario**

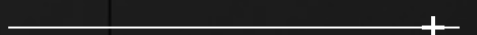

Miscelatore / Tap **Arch CS**
Doccetta / Sprayer **Show CS**



Mixology



SOPRATOP
INSET



FILOTOP
FLUSHMOUNT



Geometrie intelligenti, soluzioni modulari e flessibilità disegnano uno spazio finito dalle infinite possibilità d'uso. Creativamente ispirato alle postazioni professionali, Mixology affianca e sovrappone alla figura dello chef domestico quella del **bartender**, accendendo i riflettori sui rituali del bere evoluto e i nuovi trend della convivialità in casa.

Smart shapes, modular solutions and flexibility create a finite space with an infinite number of uses. Creatively inspired by professional workstations, Mixology juxtaposes and superimposes the figure of the home chef with that of the **bartender**, turning the spotlight on the art of mixing drinks and new trends in entertaining at home.

Caratteristiche / Features



SMART EDGE



ACCESSORI SCORREVOLI
SLIDING ACCESSORIES



VASCA EXTRA-LARGE
EXTRA-LARGE BOWL

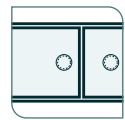

COVER A FILO
COVER FLUSHMOUNT



3 LIVELLI DI LAVORO
3 WORKTOP LEVELS



Lavello / Sink **Mixology** Black

Piano induzione 30 / Induction hob 30 **Sipario**

Miscelatore / Tap **Arch** C5
Doccetta / Sprayer **Show** C5

Mixology CLAY



Forno termoventilato / Thermoventilated oven **Sipario**
 Forno Vapore / Steam oven **Sipario**
 Cassetto Riscaldante / Warming drawer **Sipario**
 Cantinetta / Wine cellar **Sipario**
 Cassetto porta oggetti / Storage drawer **Sipario**
 Forno pirolitico / Pyrolytic oven **Sipario**

Piano Aspirante / Extractor hob **Sipario**

Miscelatore / Tap **Bahia Black**
 Doccetta / Sprayer **Show Black**



Mixology



SOPRATOP
INSET



FILOTOP
FLUSHMOUNT



L'evoluzione del concetto di workstation raggiunge l'apice: due vasche con low divider, tre livelli di lavoro e la duplice gestione dell'acqua creano due postazioni indipendenti, utilizzabili contemporaneamente. Un'infinità di accessori multifunzione interagiscono per facilitare le attività di preparazione, offrendo tutti gli strumenti con cui esprimere l'anima **chef**.

The crown of the workstation concept: two bowls with a low divider, three working levels and dual water management create two independent workstations that can be used simultaneously. A whole host of multifunctional accessories interact to facilitate preparation tasks, offering all the tools required to bring out your inner **chef**.

Caratteristiche / Features



SMART EDGE



ACCESSORI SCORREVOLI
SLIDING ACCESSORIES



VASCA EXTRA-LARGE
EXTRA-LARGE BOWL

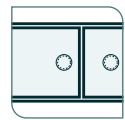

COVER A FILO
COVER FLUSHMOUNT



3 LIVELLI DI LAVORO
3 WORKTOP LEVELS



Lavello / Sink **Mixology Clay**

Miscelatore / Tap **Bahia Black**
Doccetta / Sprayer **Show Black**



Disposizione Accessori Accessories disposition

Mixology è la prima workstation Elleci a essere dotata di 3 livelli per lo scorrimento degli accessori dedicati alle molteplici attività di preparazione. Una completa selezione di taglieri, vasche e colander, declinati in più dimensioni per poter essere posizionati a seconda delle esigenze. Un'unica linea ricca di funzioni diventa il centro nevralgico della cucina.

Mixology is the first Elleci workstation to feature 3 levels on which to slide the accessories used for a variety of preparation tasks. A complete selection of chopping boards, bowls and colanders, in different sizes, that can be positioned according to your needs. A unique line packed with functions becomes the nerve centre of the kitchen.

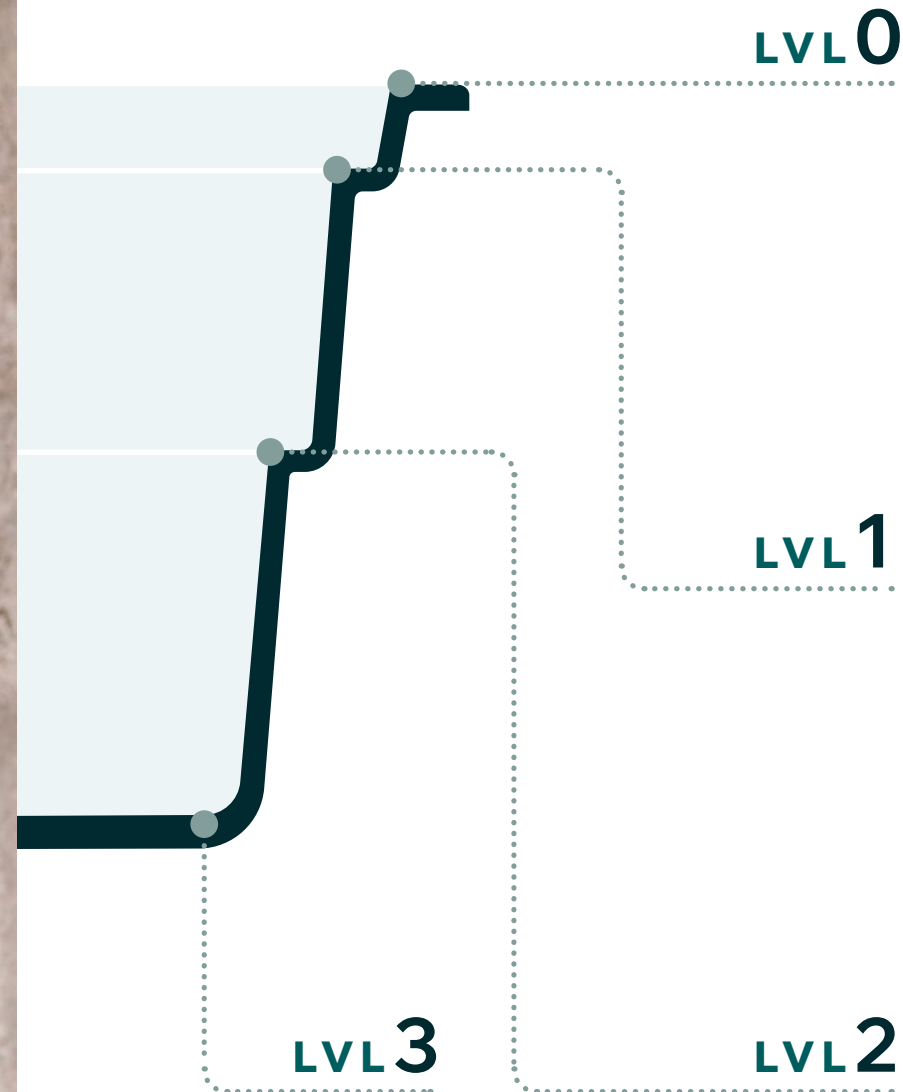

LVL 0

LVL 1

LVL 3

LVL 2

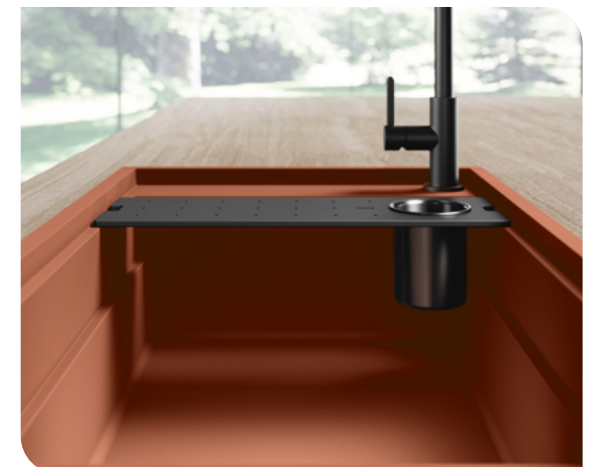
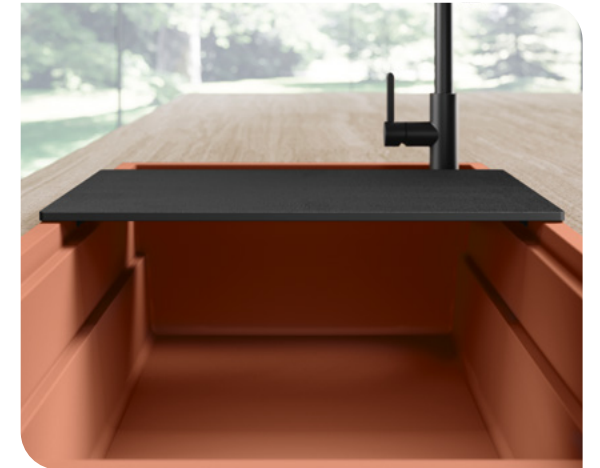

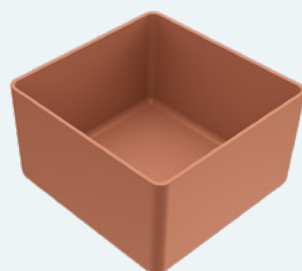
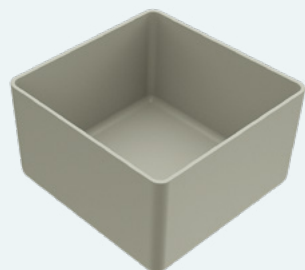

Pod

Il complemento di design
che rivoluziona i gesti quotidiani

Stile e colore incontrano funzionalità
e praticità d'uso estreme:
Elleci esplora forme estetiche
e materiali user-friendly e
disegna Pod, elemento in
silicone che stimola la creatività
e il piacere ludico in cucina.

The design accessory that revolutionises
everyday actions

Style and colour meet functionality
and ultra-practical use:
Elleci explores aesthetic shapes and
user-friendly materials by designing
Pod, silicone elements that stimulate
creativity and fun in the kitchen.



Flessibile e salvaspazio
Flexible and space-saving



Sicuro per gli alimenti
Food-grade safe



Adatto a forno e frigo
Suitable for oven and fridge



Lavabile in lavastoviglie
Dishwasher safe



Ultra resistente
Ultra durable



Ecologico
Environmentally friendly



Mixology

ACCESSORIES

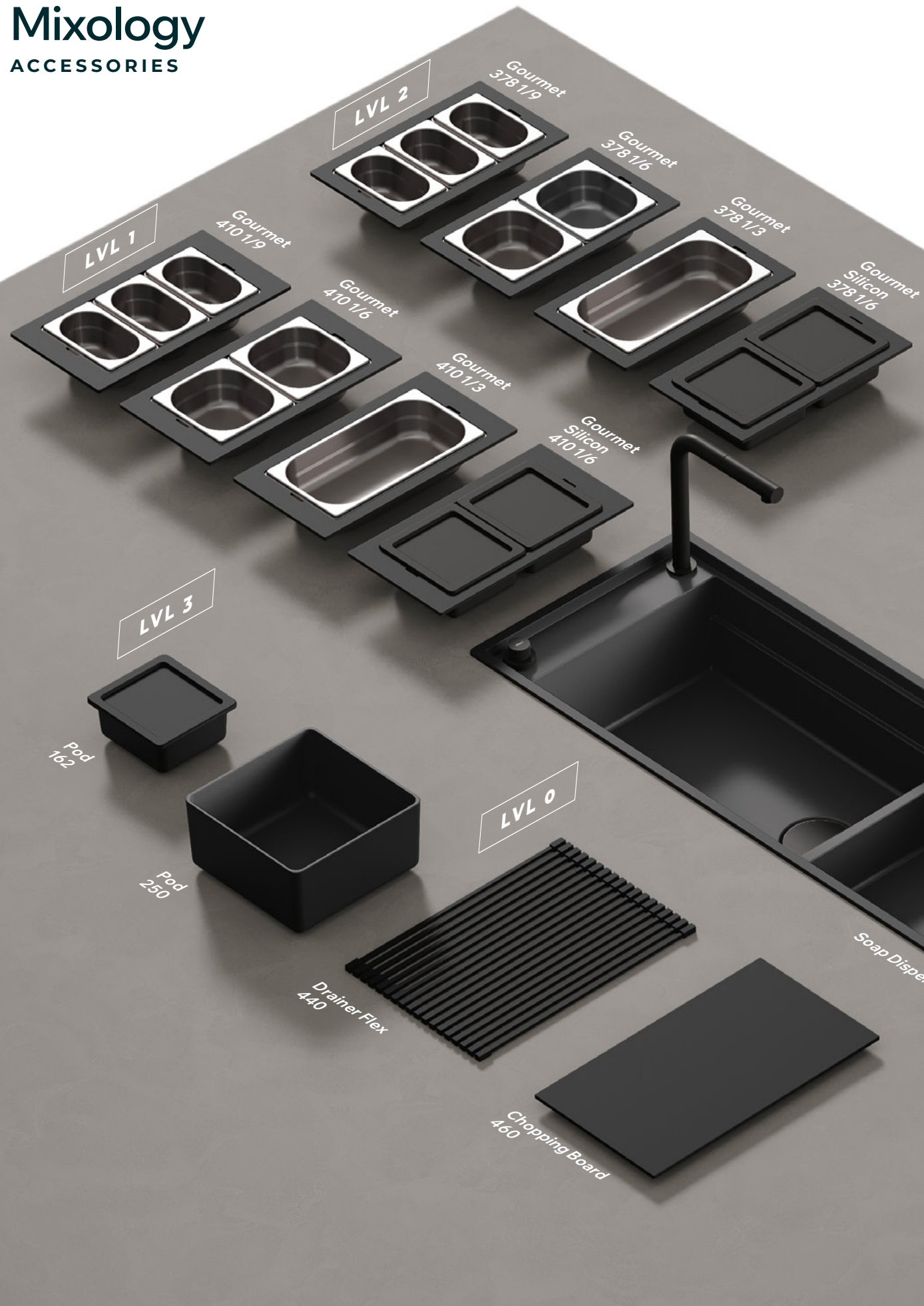

Possibili configurazioni Possible configurations

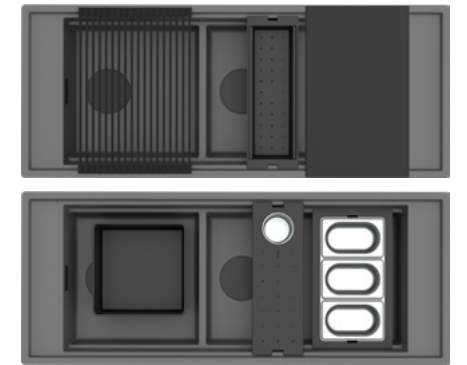

Schema posizionamento accessori Accessory placement diagram



Mixology



LAVELLO / SINK
2 Vasche - Reversibile / 2 Bowls - Reversible

BASE / BASE
1200 mm

DIMENSIONI / DIMENSIONS
1140 x 460 mm - P D 190 mm

INCASSO / BUILT-IN
Sopratop / Inset = 1130 x 450 R5
Filotop / Flushmount = consultare disegno approfondito / see technical drawing

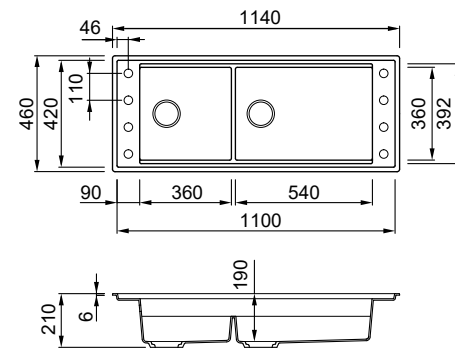

KERATEK

- | | | | |
|----------------------|--------------------------------------|------------------|--------------------------------------|
| K86 BLACK | IN LKM59086FIXCI
BK LKM59086FBXCB | K83 CLAY | IN LKM59083FIXCI
BK LKM59083FBXCB |
| K99 DARK GREY | IN LKM59099FIXCI
BK LKM59099FBXCB | K82 SAGE | IN LKM59082FIXCI
BK LKM59082FBXCB |
| K96 WHITE | IN LKM59096FIXCI
BK LKM59096FBXCB | K87 COCOA | IN LKM59087FIXCI
BK LKM59087FBXCB |

CORREDO / SINK KIT
Sifone salvaspazio, Scarico + Cover, Troppopieno rettangolare, Kit di fissaggio, 1 Pod 250.
Space-saving siphon, Waste + Cover, Rectangular overflow, Fixing Kit, 1 Pod 250.

COMPONENTI / COMPONENTS
Overflow Rettangolare Cover

FINITURE / FINISHES
IN Inox
BK Black

Mixology ACCESSORIES

Pod 250 incluso con lavello Mixology / included with Mixology sink



In abbinamento al lavello:
Matching with sink:
Black, Dark Grey, White, Cocoa

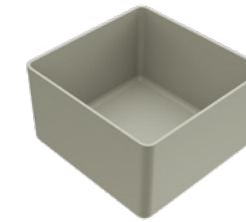

In abbinamento al lavello:
Matching with sink:
Sage

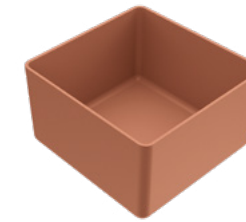

In abbinamento al lavello:
Matching with sink:
Clay

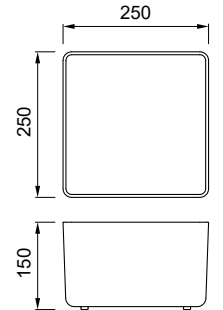

Contenitore multiuso in silicone
Silicon multi-use pod

DIMENSIONI / DIMENSIONS
250 x 250 x 150 mm

FINITURE / FINISHES

- BK Black APS250BK
- K82 Sage APS250SG
- K83 Clay APS250CL

Soap Dispenser



Dosatore sapone in metallo
Metal soap dispenser

DIMENSIONE FORO DI INCASSO / DIMENSIONS OF HOLE FOR BUILT-IN INSTALLATION
Ø 35

DIMENSIONE / DIMENSIONS
Ø 39

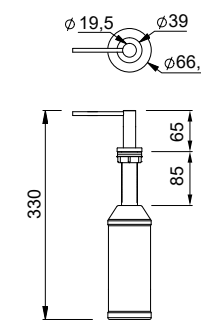

FINITURE / FINISHES
● BK Black ADI02304BK
● IN Inox ADI02304IN

Sprayer Show



Doccetta estraibile monogetto, solo acqua fredda
Single-jet pull-out sprayer, only cold water

DIMENSIONE FORO DI INCASSO / DIMENSIONS OF HOLE FOR BUILT-IN INSTALLATION
Ø 35

DIMENSIONE / DIMENSIONS
Ø 50

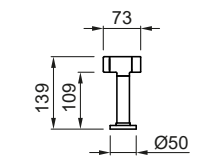

FINITURE / FINISHES
● BK Black MOKSHOBK
● IN Inox MIKSHOCS

Mixology ACCESSORIES

Chopping Board 460

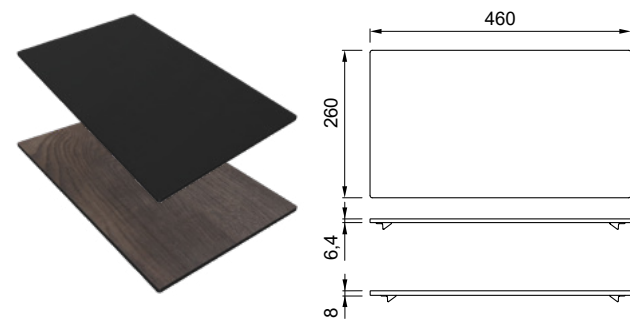

Tagliere in Woodtech / HPL
Chopping board in Woodtech / HPL

DIMENSIONI / DIMENSIONS
460 x 260 x 6,4 mm - fin. BK Black
460 x 260 x 8 mm - fin. WD Wood

FINITURE / FINISHES
● BK Black
ATT133BK
● WD Wood
ATH133WD

Tray Holder 410

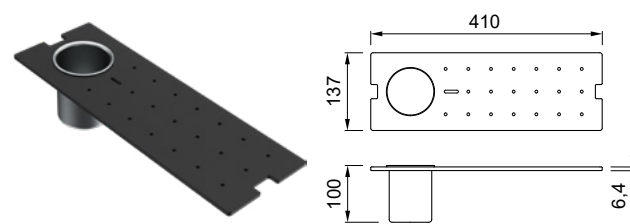

Base multiuso in Woodtech con portaposate
Multi-use base in Woodtech with rack

DIMENSIONI / DIMENSIONS
410 x 137 x 100 mm

FINITURE / FINISHES
● BK Black
AMT113BK

Mixology ACCESSORIES

Colander 378

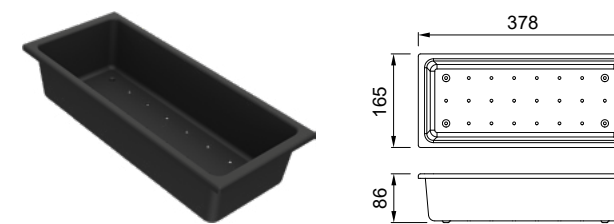

Vasca forata in polipropilene
Polypropylene colander

DIMENSIONI / DIMENSIONS
378 x 165 x 86 mm

FINITURE / FINISHES
● BK Black
AVP036BK

Bowl 378

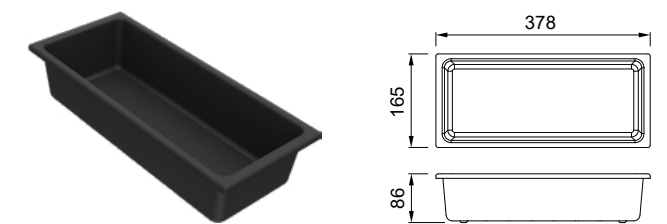

Vasca chiusa in polipropilene
Polypropylene bowl

DIMENSIONI / DIMENSIONS
378 x 165 x 86 mm

FINITURE / FINISHES
● BK Black
ABP036BK

Chopping Rack 410

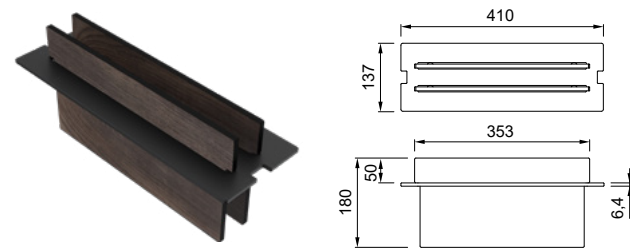

Portataglieri con struttura in Woodtech e due taglieri
Chopping Rack in Woodtech with 2 cutting boards

DIMENSIONI / DIMENSIONS
410 x 137 x 180 mm

FINITURE / FINISHES
● BK Black
KTT001BK
● WD Wood
KTT001WD

Tray 410

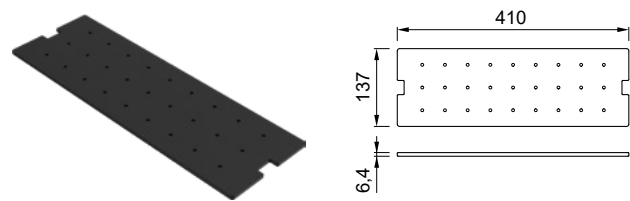

Base multiuso in Woodtech
Multi-use base in Woodtech

DIMENSIONI / DIMENSIONS
410 x 137 x 6,4 mm

FINITURE / FINISHES
● BK Black
AMT103BK

Colander 410

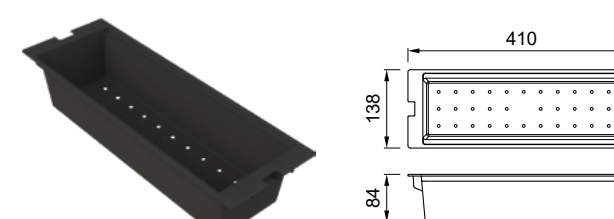

Vasca forata in polipropilene
Polypropylene colander

DIMENSIONI / DIMENSIONS
410 x 138 x 84 mm

FINITURE / FINISHES
● BK Black
AVP033BK

Drainer Flex 440

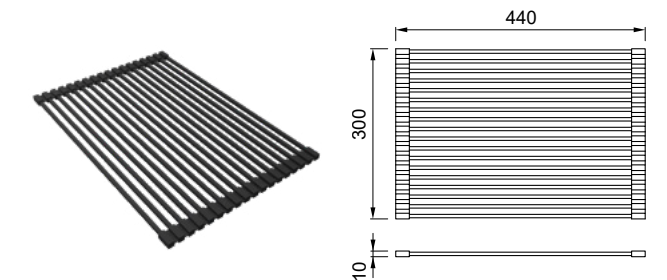

Gocciolatoio flessibile con barre in acciaio rivestite in silicone
Flexible drainer with silicon-coated steel bars

DIMENSIONI / DIMENSIONS
440 x 300 x 10 mm

FINITURE / FINISHES
● BK Black
ARS013BK

Mixology ACCESSORIES

Pod 250

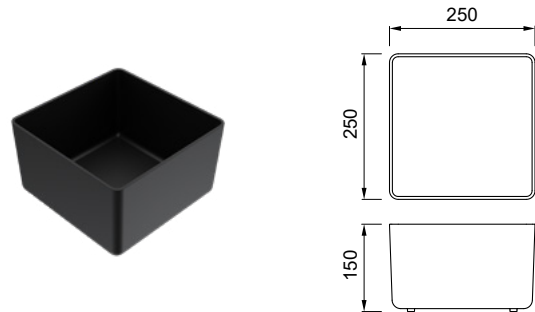

Contenitore multiuso in silicone
Silicon multi-use pod

DIMENSIONI / DIMENSIONS
250 x 250 x 150 mm

FINITURE / FINISHES

- BK Black
APS250BK
- K82 Sage
APS250SG
- K83 Clay
APS250CL

Gourmet Silicon 410 1/6

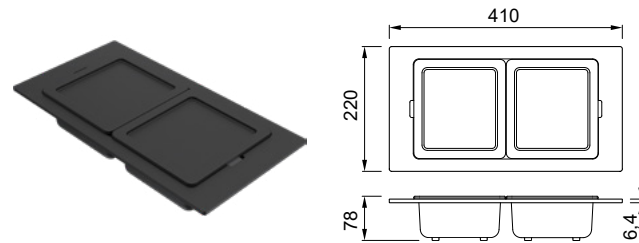

Struttura in Woodtech e vaschette con coperchio in silicone
Woodtech frame and silicon trays with cap

DIMENSIONI / DIMENSIONS
410 x 220 x 78 mm

FINITURE / FINISHES

- BK Black
KF022078BKSIL

Pod 162



Contenitore multiuso in silicone con coperchio
Silicon pod with cap

DIMENSIONI / DIMENSIONS
162 x 175 x 78 mm

FINITURE / FINISHES

- BK Black
APS162BK

Gourmet Silicon 378 1/6

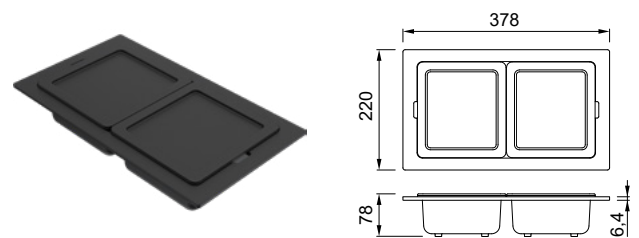

Struttura in Woodtech e vaschette con coperchio in silicone
Woodtech frame and silicon trays with cap

DIMENSIONI / DIMENSIONS
378 x 220 x 78 mm

FINITURE / FINISHES

- BK Black
KF052078BKSIL

Mixology ACCESSORIES

Gourmet 410 1/3

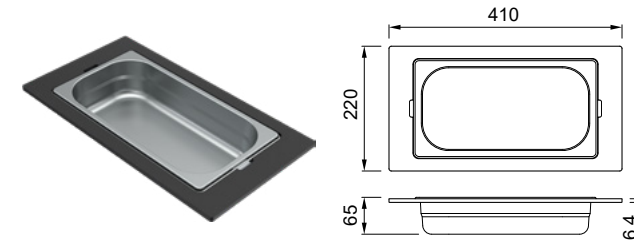

Struttura in Woodtech e vaschetta in acciaio Inox
Woodtech frame and stainless steel tray

DIMENSIONI / DIMENSIONS
410 x 220 x 65 mm

FINITURE / FINISHES

- IN Inox
KF021065IN
- BK Black
KF021065BK
- GD Gold
KF021065GD
- BZ Bronze
KF021065BZ

Gourmet 410 1/6

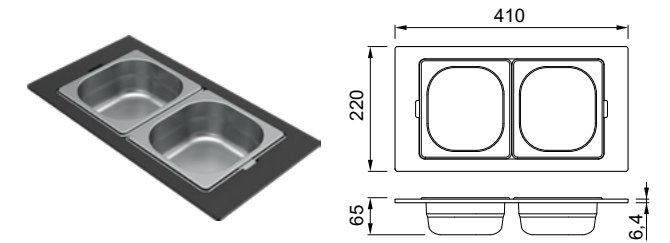

Struttura in Woodtech e vaschette in acciaio Inox
Woodtech frame and stainless steel trays

DIMENSIONI / DIMENSIONS
410 x 220 x 65 mm

FINITURE / FINISHES

FINITURE / FINISHES

- IN Inox
KF022065IN
- BK Black
KF022065BK
- GD Gold
KF022065GD
- BZ Bronze
KF022065BZ

Gourmet 410 1/9

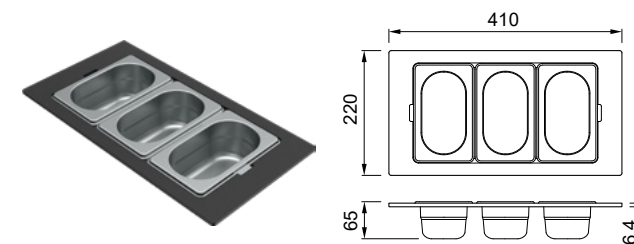

Struttura in Woodtech e vaschette in acciaio Inox
Woodtech frame and stainless steel trays

DIMENSIONI / DIMENSIONS
410 x 220 x 65 mm

FINITURE / FINISHES

- IN Inox
KF023065IN
- BK Black
KF023065BK
- GD Gold
KF023065GD
- BZ Bronze
KF023065BZ

Mixology ACCESSORIES

Gourmet 378 1/3

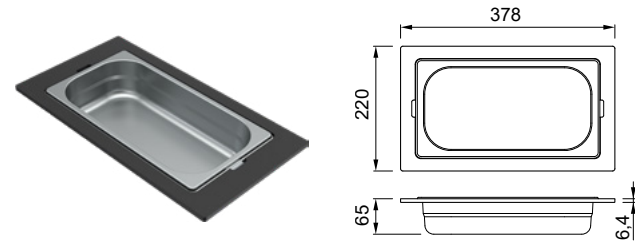

Struttura in Woodtech e vaschetta in acciaio Inox
Woodtech frame and stainless steel tray

DIMENSIONI / DIMENSIONS
378 x 220 x 65 mm

FINITURE / FINISHES

- IN Inox
KF051065IN
- BK Black
KF051065BK
- GD Gold
KF051065GD
- BZ Bronze
KF051065BZ

Gourmet 378 1/6

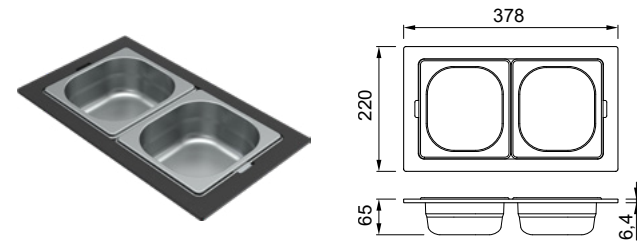

Struttura in Woodtech e vaschette in acciaio Inox
Woodtech frame and stainless steel trays

DIMENSIONI / DIMENSIONS
378 x 220 x 65 mm

FINITURE / FINISHES

- IN Inox
KF052065IN
- BK Black
KF052065BK
- GD Gold
KF052065GD
- BZ Bronze
KF052065BZ

Gourmet 378 1/9

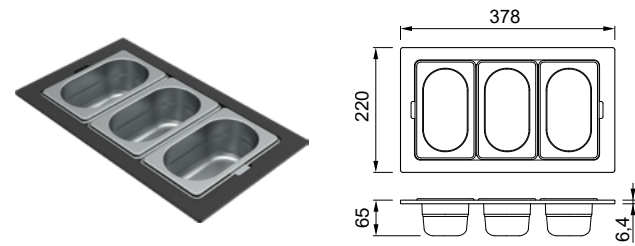

Struttura in Woodtech e vaschette in acciaio Inox
Woodtech frame and stainless steel trays

DIMENSIONI / DIMENSIONS
378 x 220 x 65 mm

FINITURE / FINISHES

- IN Inox
KF053065IN
- BK Black
KF053065BK
- GD Gold
KF053065GD
- BZ Bronze
KF053065BZ

Mixology ACCESSORIES

Kit Chef

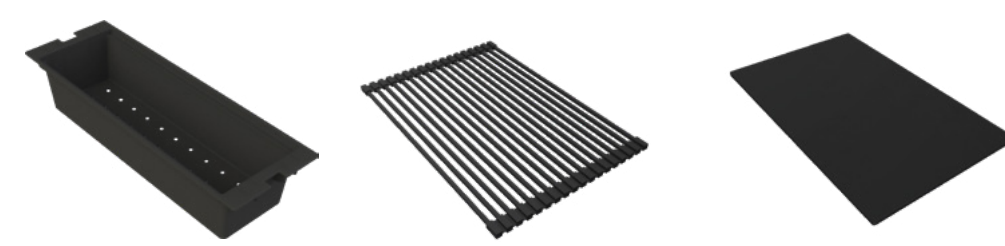

Il kit contiene: Colander 410 Black, Drainer Flex 440 Black, Chopping Board 460 Black
Kit contains: Colander 410 Black, Drainer Flex 440 Black, Chopping Board 460 Black

DIMENSIONI / DIMENSIONS
consultare sezione accessori / consult accessories section

Kit Chef
KCH001BK

Kit Bartender



Il kit contiene: Tray Holder 410 Black, Pod 250 Black, Gourmet 378 1/9 Inox
Kit contains: Tray Holder 410 Black, Pod 250 Black, Gourmet 378 1/9 Inox

DIMENSIONI / DIMENSIONS
consultare sezione accessori / consult accessories section

Kit Bartender
KBA001BK

Dialogo COCOA



red dot winner 2021
best of the best



Forno pirolitico / Pyrolytic oven **Sipario**
Forno Vapore / Steam oven **Sipario**
Cassetto Riscaldante / Warming drawer **Sipario**

Piano Aspirante / Extractor hob **Sipario**

Miscelatore / Tap **Arch Bronze**



Dialogo



SOPRATOP
INSET



SOTTOTOP
UNDERMOUNT



L'intuizione è un lampo di genio. L'area di preparazione evolve in un sistema armonioso in cui tutti gli elementi collaborano potenziando le prestazioni. Il design razionale sfrutta il volume della vasca extralarge a inclinazione maggiorata per migliorare il deflusso dell'acqua; la cover in Keratek nasconde lo scarico e dona continuità estetica.

Intuition is a light-bulb moment. The preparation area evolves into a seamless system in which all elements work together, enhancing performance. The rational design exploits the size of the extra-large bowl, slanted to improve drainage; the Keratek cover blends in seamlessly to conceal the drain.

Caratteristiche / Features



SMART EDGE

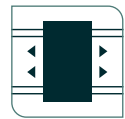

ACCESSORI SCORREVOLI
SLIDING ACCESSORIES



VASCA EXTRA-LARGE
EXTRA-LARGE BOWL

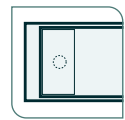

COVER INTEGRATA
INTEGRATED COVER



Lavello / Sink **Dialogo** Cocoa



Miscelatore / Tap **Arch** Bronze

Dialogo

WHITE



red dot winner 2021
best of the best

Forno pirolitico / Pyrolytic oven **Sipario**
Cantinetta / Wine cellar **Sipario**
Cassetto porta oggetti / Storage drawer **Sipario**

Piano Induzione 80 / Induction hob 80 **Sipario**

Miscelatore / Tap **Eclipse Black**



Dialogo



SOPRATOP
INSET



SOTTOTOP
UNDERMOUNT



Il canale attrezzato è il plus esclusivo della collezione Dialogo: uno spazio complementare concepito per valorizzare la modularità e la totale intercambiabilità con gli accessori della vasca principale. Ergonomia, capienza e funzionalità si uniscono a una raffinata sensibilità estetica e cura dei dettagli, secondo i desideri del lifestyle contemporaneo.

The signature feature of Dialogo collection is the equipped track: an additional space designed to enhance modularity and allow total interchangeability with the accessories of the main sink. Ergonomics, volume and functionality are combined with elegant visual appeal and attention to detail, in keeping with the demands of contemporary lifestyle.

Caratteristiche / Features



SMART EDGE

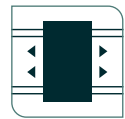

ACCESSORI SCORREVOLI
SLIDING ACCESSORIES



VASCA EXTRA-LARGE
EXTRA-LARGE BOWL

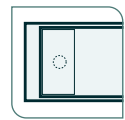

COVER INTEGRATA
INTEGRATED COVER



Lavello / Sink **Dialogo** White

Canale attrezzato / Equipped track **Dialogo** White

Miscelatore / Tap **Eclipse** Black

Dialogo ACCESSORIES

Possibili configurazioni
Possible configurations



Schema posizionamento accessori
Accessory placement diagram

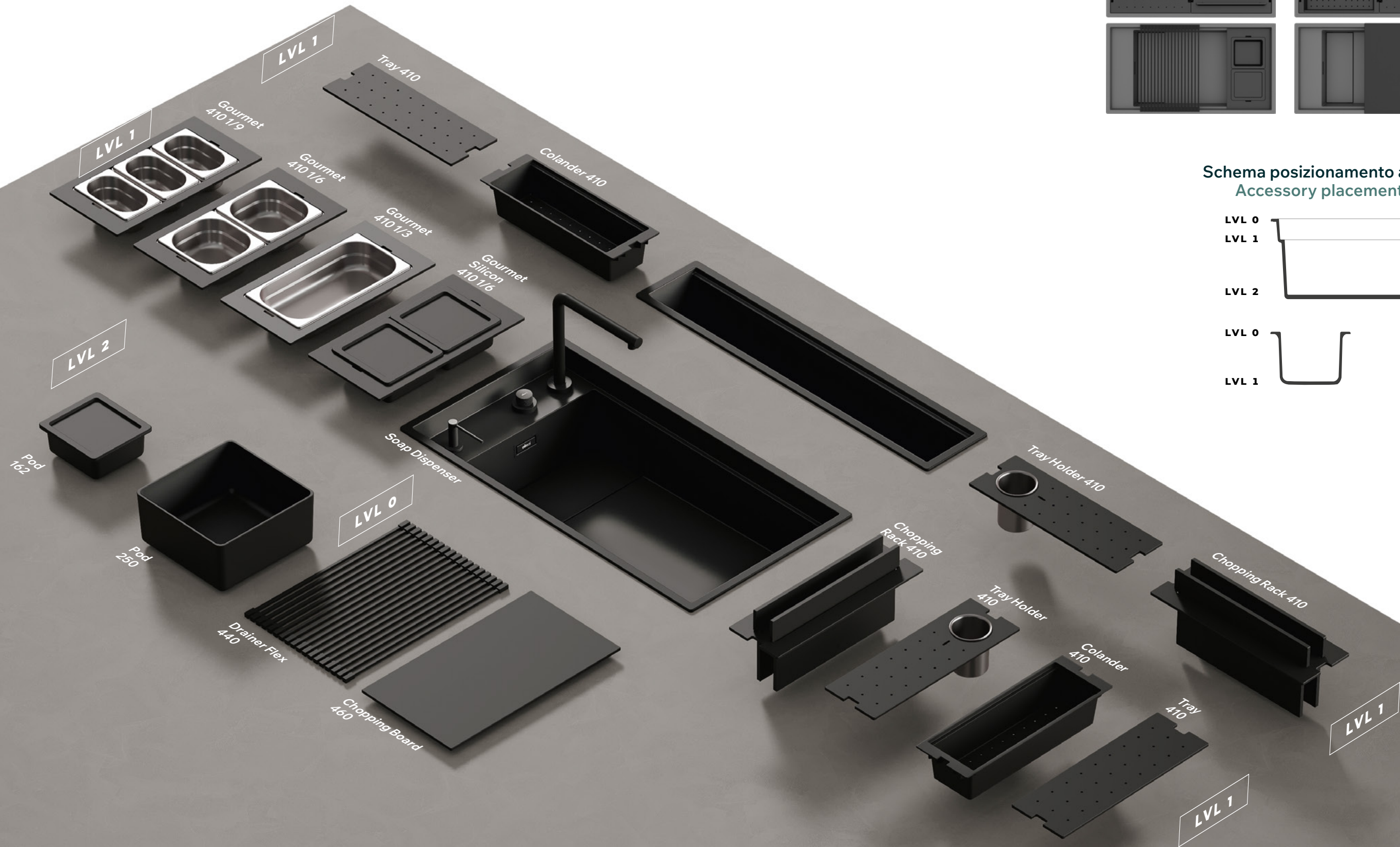
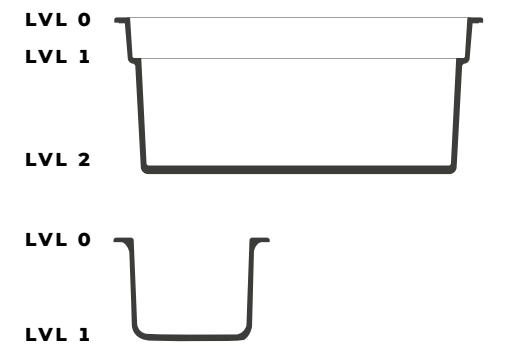

Dialogo

Dialogo canale attrezzato

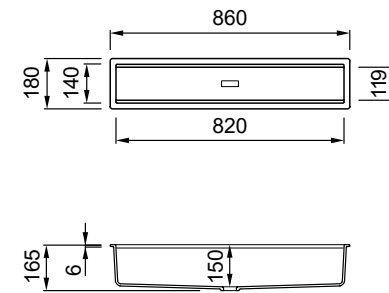

LAVELLO / SINK
Accessorio 1 vasca / 1 Accessory sink

BASE / BASE
900 mm

DIMENSIONI / DIMENSIONS
860 x 180 mm - P D 150 mm

INCASSO / BUILT-IN
Sopratop / Inset = 850 x 170 R5 mm
Sottotop / Undermount = 820 x 140 R4 mm

KERATEK

K86 BLACK	IN LKDC8686	K83 CLAY	IN LKDC8683
	BK LKDC8686BKM		BK LKDC8683BKM
	GD LKDC8686GLD		GD LKDC8683GLD
	BZ LKDC8686BRZ		BZ LKDC8683BRZ
K99 DARK GREY	IN LKDC8699	K82 SAGE	IN LKDC8682
	BK LKDC8699BKM		BK LKDC8682BKM
	GD LKDC8699GLD		GD LKDC8682GLD
	BZ LKDC8699BRZ		BZ LKDC8682BRZ
K96 WHITE	IN LKDC8696	K87 COCOA	IN LKDC8687
	BK LKDC8696BKM		BK LKDC8687BKM
	GD LKDC8696GLD		GD LKDC8687GLD
	BZ LKDC8696BRZ		BZ LKDC8687BRZ

CORREDO / SINK KIT
Sifone salvaspazio, Flow Pro, Troppopieno rettangolare, Kit di fissaggio.
Space-saving siphon, Flow Pro waste, Rectangular Overflow, Fixing Kit.
Canale attrezzato: elemento di raccordo allo scarico principale.
Equipped track: connection element to the main drain.

COMPONENTI / COMPONENTS
 Overflow Rettangolare
 Flow Pro

FINITURE / FINISHES
 IN Inox
 GD Gold
 BK Black
 BZ Bronze

Dialogo

Dialogo

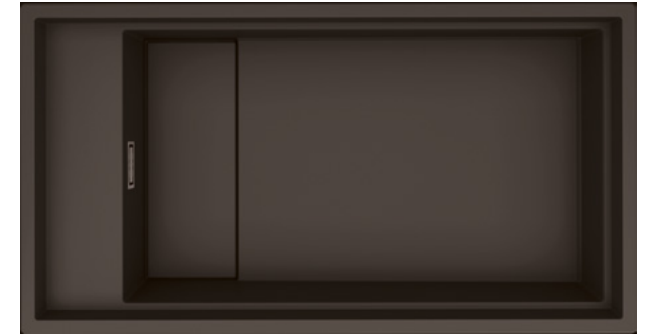

LAVELLO / SINK
1 Vasca - Reversibile / 1 Bowl - Reversible

BASE / BASE
900 mm

DIMENSIONI / DIMENSIONS
860 x 460 mm - P D 220 mm

INCASSO / BUILT-IN
Sopratop / Inset = 850 x 450 R5 mm
Sottotop / Undermount = 820 x 420 R4 mm

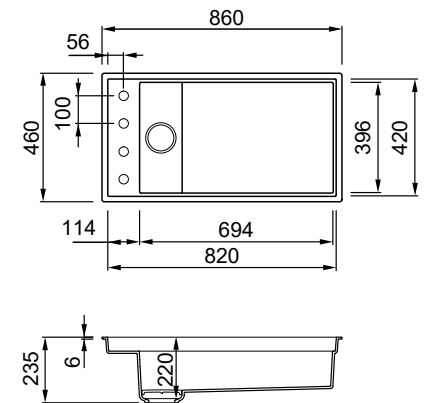

KERATEK

K86 BLACK	IN LKD36086	K83 CLAY	IN LKD36083
	BK LKD36086BKM		BK LKD36083BKM
	GD LKD36086GLD		GD LKD36083GLD
	BZ LKD36086BRZ		BZ LKD36083BRZ
K99 DARK GREY	IN LKD36099	K82 SAGE	IN LKD36082
	BK LKD36099BKM		BK LKD36082BKM
	GD LKD36099GLD		GD LKD36082GLD
	BZ LKD36099BRZ		BZ LKD36082BRZ
K96 WHITE	IN LKD36096	K87 COCOA	IN LKD36087
	BK LKD36096BKM		BK LKD36087BKM
	GD LKD36096GLD		GD LKD36087GLD
	BZ LKD36096BRZ		BZ LKD36087BRZ

Dialogo ACCESSORIES

Flow Pro Open Up

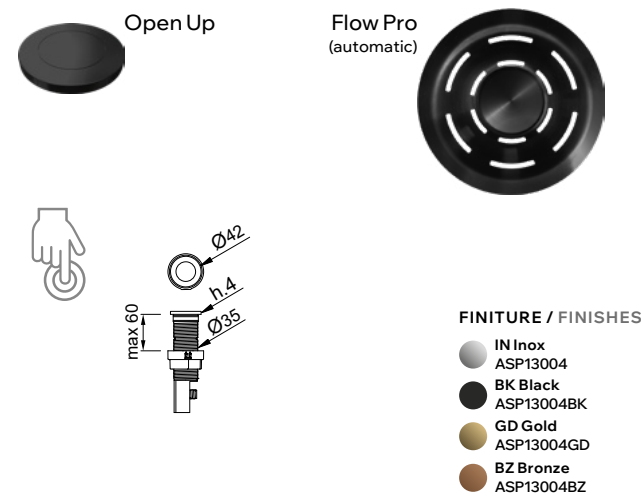

Sistema di scarico 1 via Flow Pro con comando remoto Open Up
1-way automatic Flow Pro drainer system with Open Up remote control

DIMENSIONE / DIMENSIONS
Ø 42

- FINITURE / FINISHES**
- IN Inox ASP13004
 - BK Black ASP13004BK
 - GD Gold ASP13004GD
 - BZ Bronze ASP13004BZ

Flow Pro Open Twist

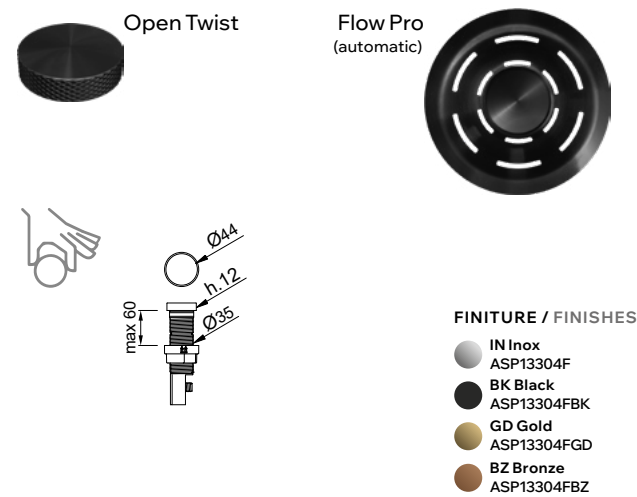

Sistema di scarico 1 via Flow Pro con comando remoto Open Twist
1-way automatic Flow Pro drainer system with Open Twist remote control

DIMENSIONE / DIMENSIONS
Ø 44

- FINITURE / FINISHES**
- IN Inox ASP13304F
 - BK Black ASP13304FBK
 - GD Gold ASP13304FGD
 - BZ Bronze ASP13304FBZ

Soap Dispenser

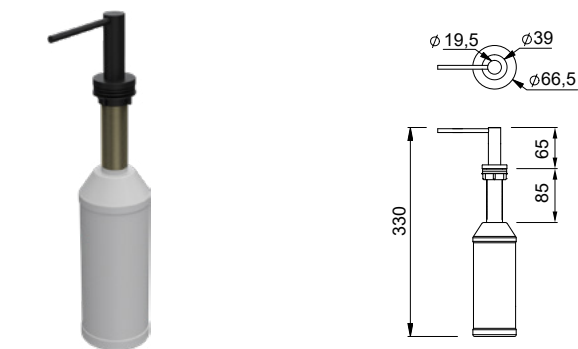

Dosatore sapone in metallo
Metal soap dispenser

DIMENSIONE FORO DI INCASSO / DIMENSIONS OF HOLE FOR BUILT-IN INSTALLATION
Ø 35

DIMENSIONE / DIMENSIONS
Ø 39

- FINITURE / FINISHES**
- BK Black ADI02304BK
 - IN Inox ADI02304IN

Sprayer Show



Doccetta estraibile monogetto, solo acqua fredda
Single-jet pull-out sprayer, only cold water

DIMENSIONE FORO DI INCASSO / DIMENSIONS OF HOLE FOR BUILT-IN INSTALLATION
Ø 35

DIMENSIONE / DIMENSIONS
Ø 50

- FINITURE / FINISHES**
- BK Black MOKSHOBK
 - IN Inox MIKSHOCS

Dialogo ACCESSORIES

Chopping Board 460

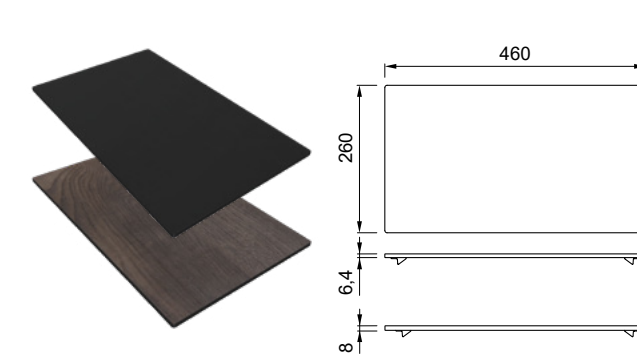

Tagliere in Woodtech / HPL
Chopping board in Woodtech / HPL

DIMENSIONI / DIMENSIONS
460 x 260 x 6,4 mm - fin. BK Black
460 x 260 x 8 mm - fin. WD Wood

- FINITURE / FINISHES**
- BK Black ATT133BK
 - WD Wood ATH133WD

Tray Holder 410

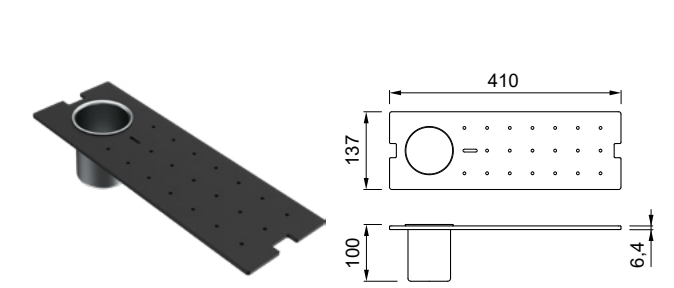

Base multiuso in Woodtech con portaposate
Multi-use base in Woodtech with rack

DIMENSIONI / DIMENSIONS
410 x 137 x 100 mm

- FINITURE / FINISHES**
- BK Black AMT113BK

Chopping Rack 410

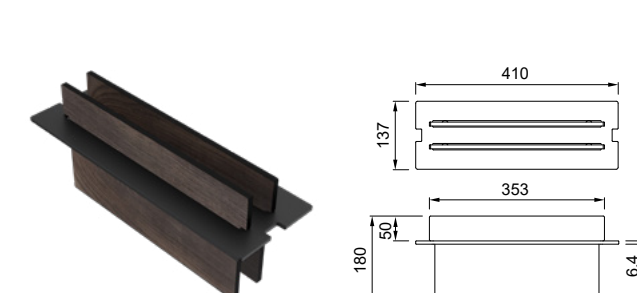

Portataglieri con struttura in Woodtech e due taglieri
Chopping Rack in Woodtech with 2 cutting boards

DIMENSIONI / DIMENSIONS
410 x 137 x 180 mm

- FINITURE / FINISHES**
- BK Black KTT001BK
 - WD Wood KTT001WD

Tray 410

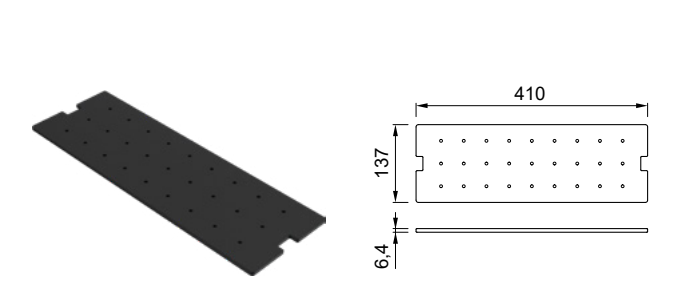

Base multiuso in Woodtech
Multi-use base in Woodtech

DIMENSIONI / DIMENSIONS
410 x 137 x 6,4 mm

- FINITURE / FINISHES**
- BK Black AMT103BK

Dialogo ACCESSORIES

Pod 250

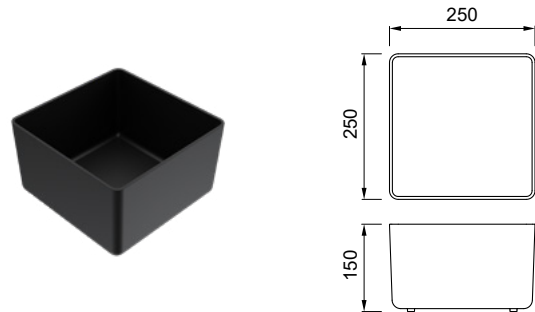

Contenitore multiuso in silicone
Silicon multi-use pod

DIMENSIONI / DIMENSIONS
250 x 250 x 150 mm

FINITURE / FINISHES

- BK Black
APS250BK
- K82 Sage
APS250SG
- K83 Clay
APS250CL

Gourmet Silicon 410 1/6

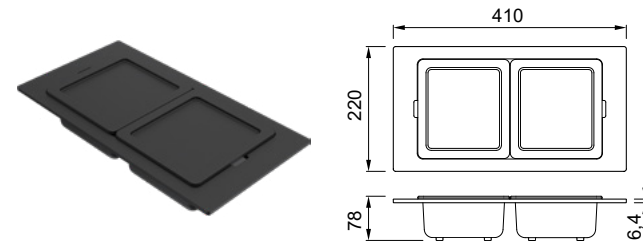

Struttura in Woodtech e vaschette con coperchio in silicone
Woodtech frame and silicon trays with cap

DIMENSIONI / DIMENSIONS
410 x 220 x 78 mm

FINITURE / FINISHES

- BK Black
KF022078BKSIL

Gourmet 410 1/3

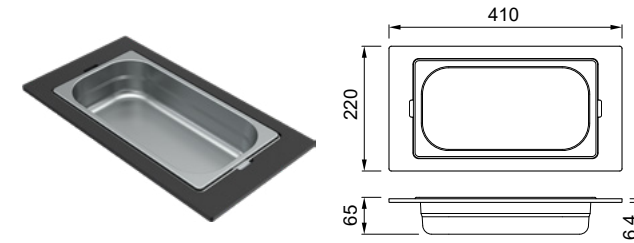

Struttura in Woodtech e vaschetta in acciaio Inox
Woodtech frame and stainless steel tray

DIMENSIONI / DIMENSIONS
410 x 220 x 65 mm

FINITURE / FINISHES

- IN Inox
KF021065IN
- BK Black
KF021065BK
- GD Gold
KF021065GD
- BZ Bronze
KF021065BZ

Gourmet 410 1/6

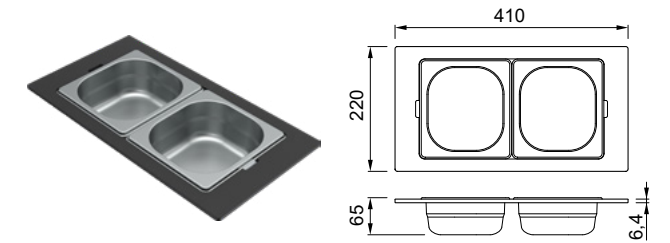

Struttura in Woodtech e vaschette in acciaio Inox
Woodtech frame and stainless steel trays

DIMENSIONI / DIMENSIONS
410 x 220 x 65 mm

FINITURE / FINISHES

- IN Inox
KF022065IN
- BK Black
KF022065BK
- GD Gold
KF022065GD
- BZ Bronze
KF022065BZ

Pod 162



Contenitore multiuso in silicone con coperchio
Silicon pod with cap

DIMENSIONI / DIMENSIONS
162 x 175 x 78 mm

FINITURE / FINISHES

- BK Black
APS162BK

Colander 410

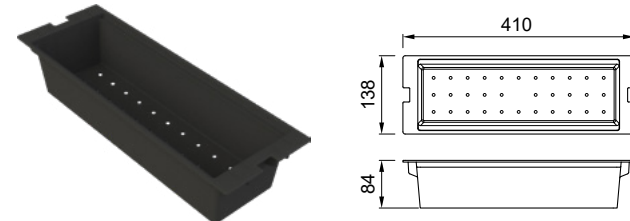

Vasca forata in polipropilene
Polypropylene colander

DIMENSIONI / DIMENSIONS
410 x 138 x 84 mm

FINITURE / FINISHES

- BK Black
AVP033BK

Gourmet 410 1/9

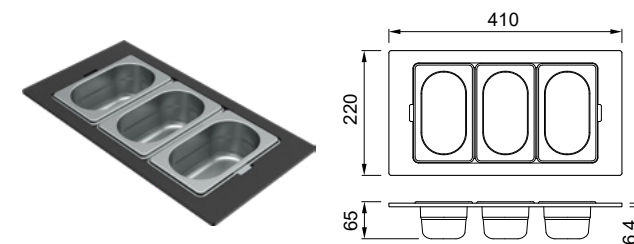

Struttura in Woodtech e vaschette in acciaio Inox
Woodtech frame and stainless steel trays

DIMENSIONI / DIMENSIONS
410 x 220 x 65 mm

FINITURE / FINISHES

- IN Inox
KF023065IN
- BK Black
KF023065BK
- GD Gold
KF023065GD
- BZ Bronze
KF023065BZ

Drainer Flex 440

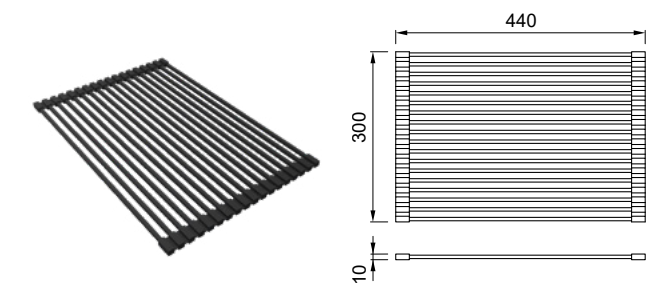

Gocciolatoio flessibile con barre in acciaio rivestite in silicone
Flexible drainer with silicon-coated steel bars

DIMENSIONI / DIMENSIONS
440 x 300 x 10 mm

FINITURE / FINISHES

- BK Black
ARS013BK



Sintesi 305

SAGE



red dot winner 2024

Forno termoventilato / Termoventilated oven **Sipario**
 Cantinetta / Wine cellar **Sipario**
 Cassetto porta oggetti / Storage drawer **Sipario**
 Forno microonde / Microwave oven **Sipario**
 Cassetto riscaldante / Warm drawer **Sipario**

Piano Induzione 80 / Induction hob 80 **Sipario**

Miscelatore / Tap **Baron Black + Sage**



Sintesi

COLLECTION



SOPRATOP
INSET



FILOTOP
FLUSHMOUNT



La genesi della collezione Sintesi è l'aspirazione a raggiungere il più elevato livello di stile e comfort nelle cucine di ogni modularità. Una gamma che si declina in modelli differenti per creare valore in tutti gli spazi: dalle capienti vasche XL alle versioni con area operativa ribassata, sino a soluzioni di workstation compatta.

The aim of Sintesi collection is to achieve the highest level of style and comfort in all modular kitchens. A range that comes in a variety of models to add value to any space: from spacious XL bowls to versions with a lowered work area and compact workstation solutions.

Caratteristiche / Features



SMART EDGE

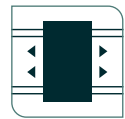

ACCESSORI SCORREVOLI
SLIDING ACCESSORIES



VASCA EXTRA-LARGE
EXTRA-LARGE BOWL

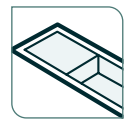

AREA OPERATIVA INTEGRATA
MULTI FUNCTIONAL AREA



Lavello / Sink **Sintesi 305 Sage**

Miscelatore / Tap **Baron Black + Sage**



Sintesi 130

DARK GREY



Forno termoventilato / Termoventilated oven **Sipario**
 Cantinetta / Wine cellar **Sipario**
 Cassetto porta oggetti / Storage drawer **Sipario**

Piano aspirante / Extractor hob **Sipario**

Miscelatore / Tap **Flamingo Pure CS**



Sintesi COLLECTION



SOPRATOP
INSET



FILOTOP
FLUSHMOUNT



Il bordo dal design ultrasottile favorisce la duplice possibilità di installazione per integrarsi con tutti gli elementi; l'originale reinterpretazione dell'area tecnica permette di ospitare miscelatore, comandi remoti e piccoli complementi come il dosatore sapone; sui rail interni poggiano e scorrono gli accessori multifunzione.

The ultra-slim edge is perfect for dual installation options to integrate with all the elements; the original reinterpretation of the technical area makes space for the mixer tap, remote controls and small accessories such as the soap dispenser; multi-purpose accessories rest and slide on the internal rails.

Caratteristiche / Features



SMART EDGE



ACCESSORI SCORREVOLI
SLIDING ACCESSORIES



VASCA EXTRA-LARGE
EXTRA-LARGE BOWL

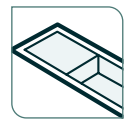

AREA OPERATIVA INTEGRATA
MULTI FUNCTIONAL AREA



Lavello / Sink **Sintesi 130** Dark grey

Miscelatore / Tap **Flamingo Pure CS**



Sintesi 510 BLACK



reddot winner 2022

Forno pirolytico / Pyrolytic oven **Sipario**
Forno vapore / Steam oven **Sipario**

Piano gas 75 / Gas hob 75 **Plano Plus**

Miscelatore / Tap **Arch Bronze**



Sintesi

COLLECTION



SOPRATOP
INSET



FILOTOP
FLUSHMOUNT



Eleganza minimalista, ergonomia ed efficienza: la linea Sintesi soddisfa tutti i canoni stilistici dell'interior design. Nelle versioni con area operativa integrata, quest'ultima diviene un armonioso spazio funzionale, garantendo facilità d'uso, ordine e igiene.

Minimalist elegance, ergonomics and efficiency: Sintesi line meets all the standards for style dictated by interior design. For versions with an integrated work area, the latter becomes an elegant functional space that is ease of use and keep clean and tidy.

Caratteristiche / Features



SMART EDGE



ACCESSORI SCORREVOLI
SLIDING ACCESSORIES



VASCA EXTRA-LARGE
EXTRA-LARGE BOWL

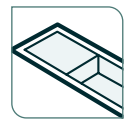

AREA OPERATIVA INTEGRATA
MULTI FUNCTIONAL AREA



Sintesi

Possibili configurazioni
Possible configurations

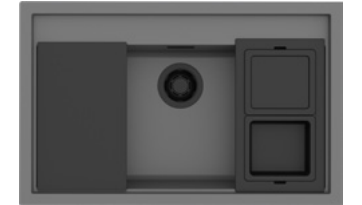
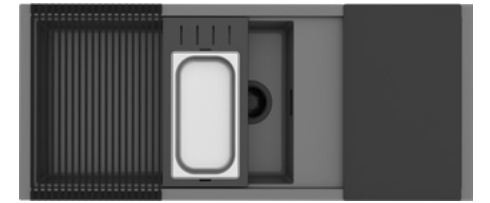

Schema posizionamento accessori
Accessory placement diagram

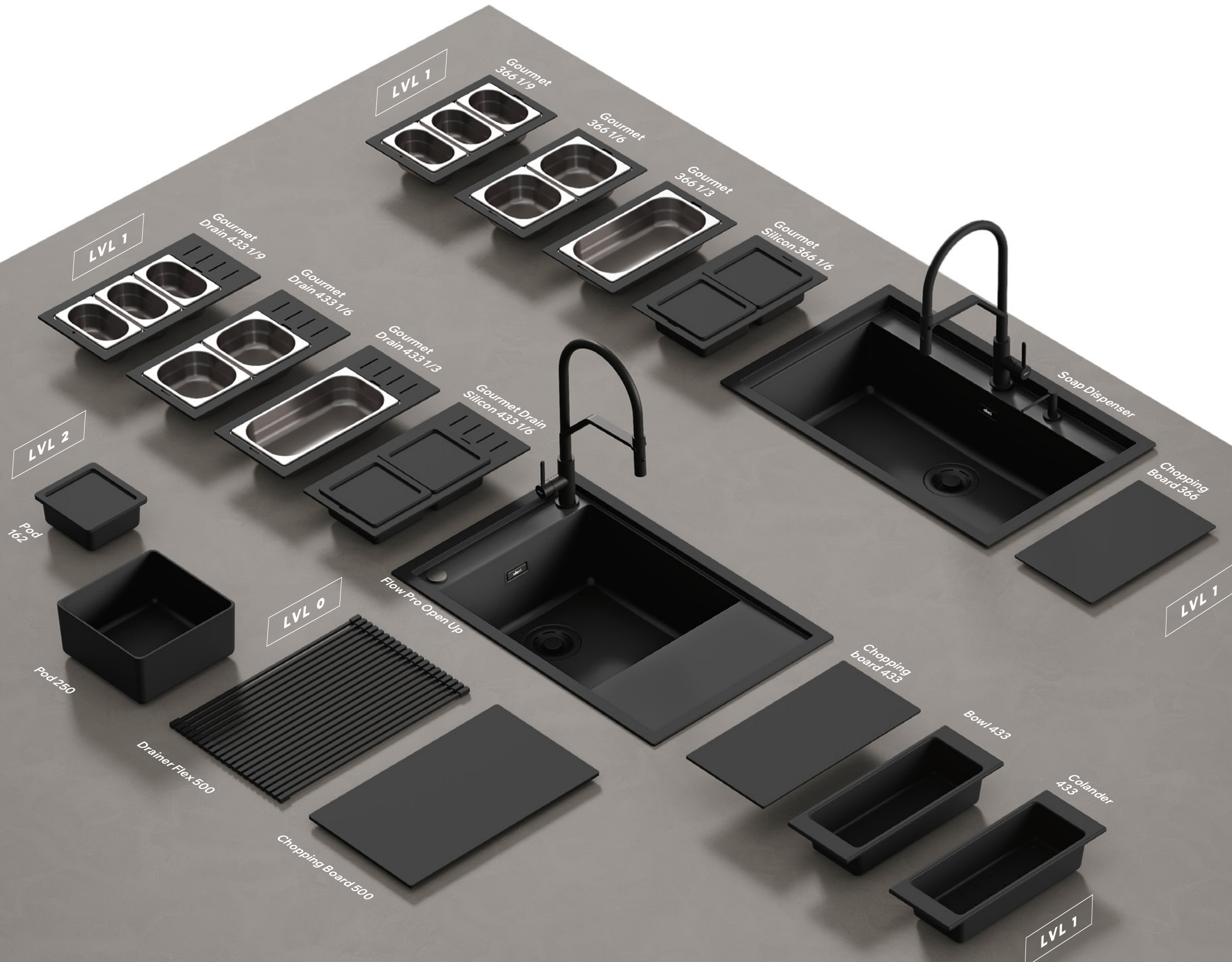
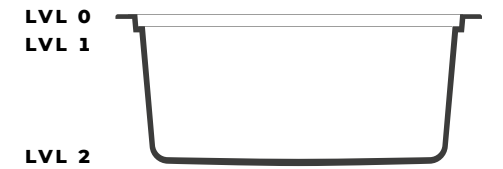

Sintesi



Sintesi 510



reddot winner 2022

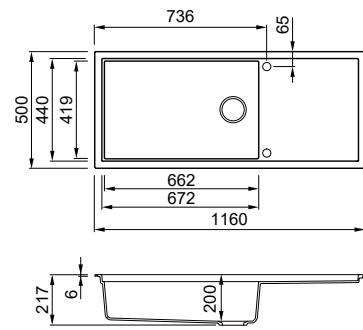

LAVELLO / SINK
Lavello 1 vasca con gocciolatoio - Reversibile / 1-bowl sink with drainer - Reversible

DIMENSIONI / DIMENSIONS
1160 x 500 mm - P D 200 mm

INCASSO / BUILT-IN
Sopratop / Inset = 1140 x 480 mm
Filotop / Flushmount = consultare disegno approfondito / see technical drawing

BASE SOPRATOP / INSET BASE
• Top ≥ 35 mm
800 mm
• Top < 35 mm
1200 mm

BASE FILOTOP / BUILT-IN BASE
• Top ≥ 40 mm
800 mm
• Top < 40 mm
1200 mm

KERATEK



Sintesi 480

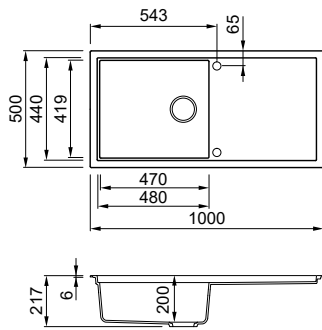
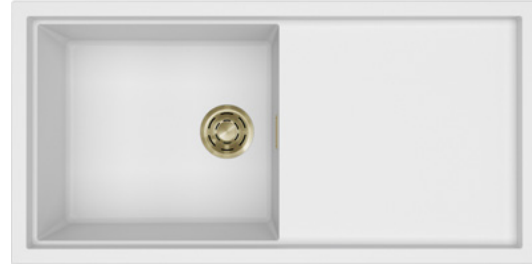

LAVELLO / SINK
Lavello 1 vasca con gocciolatoio - Reversibile / 1-bowl sink with drainer - Reversible

DIMENSIONI / DIMENSIONS
1000 x 500 mm - P D 200 mm

INCASSO / BUILT-IN
Sopratop / Inset = 980 x 480 mm
Filotop / Flushmount = consultare disegno approfondito / see technical drawing

BASE SOPRATOP / INSET BASE
• Top ≥ 35 mm
600 mm
• Top < 35 mm
1200 mm

BASE FILOTOP / BUILT-IN BASE
• Top ≥ 40 mm
600 mm
• Top < 40 mm
1200 mm

KERATEK



Sintesi SINKS



Sintesi 410

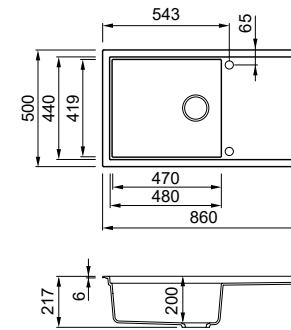
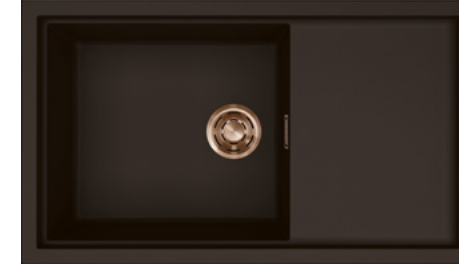

LAVELLO / SINK
Lavello 1 vasca con gocciolatoio - Reversibile / 1-bowl sink with drainer - Reversible

DIMENSIONI / DIMENSIONS
860 x 500 mm - P D 200 mm

INCASSO / BUILT-IN
Sopratop / Inset = 840 x 480 mm
Filotop / Flushmount = consultare disegno approfondito / see technical drawing

BASE SOPRATOP / INSET BASE
• Top ≥ 35 mm
600 mm
• Top < 35 mm
900 mm

BASE FILOTOP / BUILT-IN BASE
• Top ≥ 40 mm
600 mm
• Top < 40 mm
900 mm

KERATEK



Sintesi 305

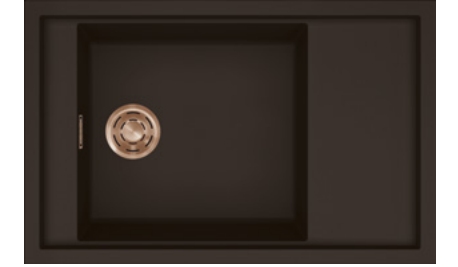

reddot winner 2024

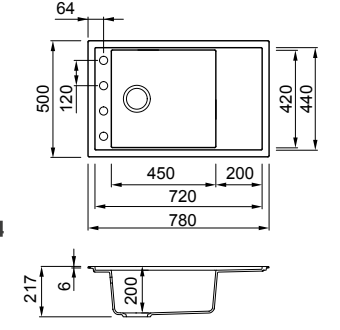

LAVELLO / SINK
Lavello 1 vasca con gocciolatoio - Reversibile / 1-bowl sink with drainer - Reversible

DIMENSIONI / DIMENSIONS
780 x 500 mm - P D 200 mm

INCASSO / BUILT-IN
Sopratop / Inset = 760 x 480 mm
Filotop / Flushmount = consultare disegno approfondito / see technical drawing

BASE SOPRATOP / INSET BASE
• Top ≥ 20 mm
600 mm
• Top < 20 mm
800 mm

BASE FILOTOP / BUILT-IN BASE
• Top ≥ 30 mm
600 mm
• Top < 30 mm
800 mm

KERATEK



CORREDO / SINK KIT
Sifone salvaspazio, Flow Pro, Troppopieno rettangolare, Kit di fissaggio.
Space-saving siphon, Flow Pro waste, Rectangular Overflow, Fixing Kit.

COMPONENTI / COMPONENTS
Overflow Rettangolare, Flow Pro

FINITURE / FINISHES
IN Inox, BK Black, GD Gold, BZ Bronze

Sintesi ACCESSORIES

Flow Pro Open Up

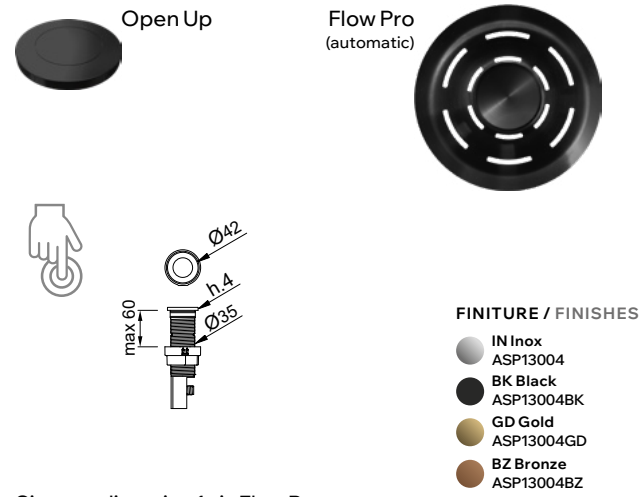

Sistema di scarico 1 via Flow Pro con comando remoto Open Up
1-way automatic Flow Pro drainer system with Open Up remote control
DIMENSIONE / DIMENSIONS
Ø 42

Flow Pro Open Twist

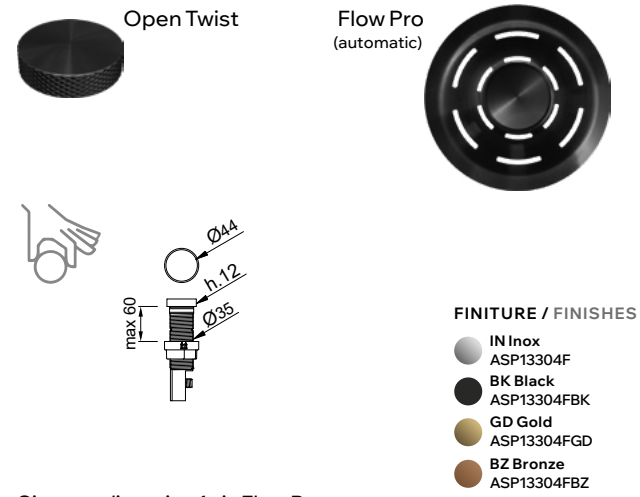

Sistema di scarico 1 via Flow Pro con comando remoto Open Twist
1-way automatic Flow Pro drainer system with Open Twist remote control
DIMENSIONE / DIMENSIONS
Ø 44

Soap Dispenser

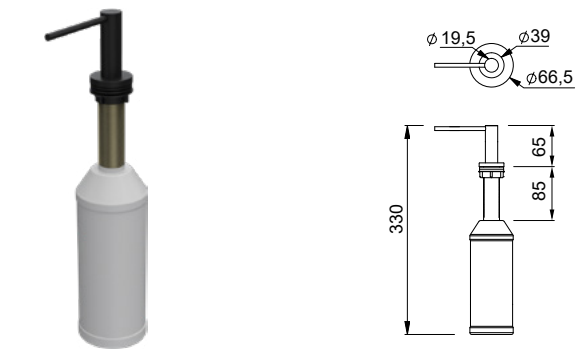

Dosatore sapone in metallo
Metal soap dispenser

DIMENSIONE FORO D I INCASSO / DIMENSIONS OF HOLE FOR BUILT-IN INSTALLATION
Ø 35
DIMENSIONE / DIMENSIONS
Ø 39

FINITURE / FINISHES

- BK Black ADI02304BK
- IN Inox ADI02304IN

Sprayer Show



Doccetta estraibile monogetto, solo acqua fredda
Single-jet pull-out sprayer, only cold water

DIMENSIONE FORO D I INCASSO / DIMENSIONS OF HOLE FOR BUILT-IN INSTALLATION
Ø 35
DIMENSIONE / DIMENSIONS
Ø 50

FINITURE / FINISHES

- BK Black MOKSHOBK
- IN Inox MIKSHOCS

Sintesi ACCESSORIES

Chopping Board 500

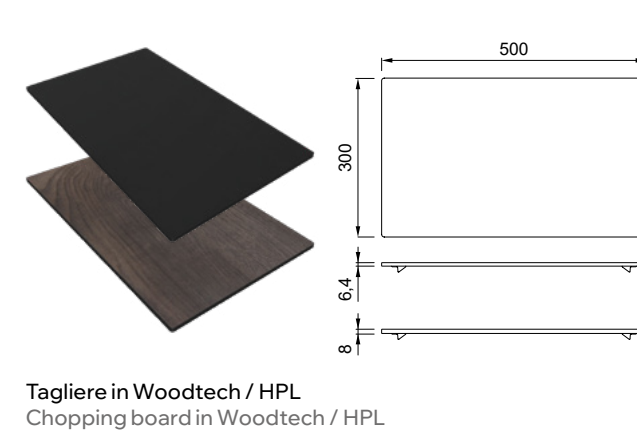

DIMENSIONI / DIMENSIONS
500 x 300 x 6,4 mm - fin. BK Black
500 x 300 x 8 mm - fin. WD Wood

FINITURE / FINISHES

- BK Black ATH093BK
- WD Wood ATH093WD

Chopping Board 433

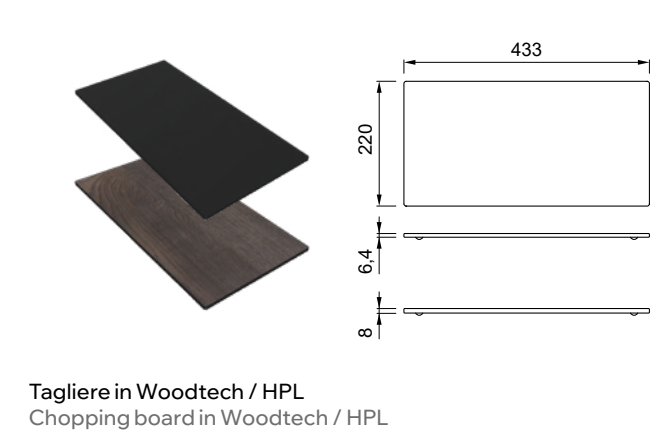

DIMENSIONI / DIMENSIONS
433 x 220 x 6,4 mm - fin. BK Black
433 x 220 x 8 mm - fin. WD Wood

FINITURE / FINISHES

- BK Black ATH103BK
- WD Wood ATH103WD

Colander 433

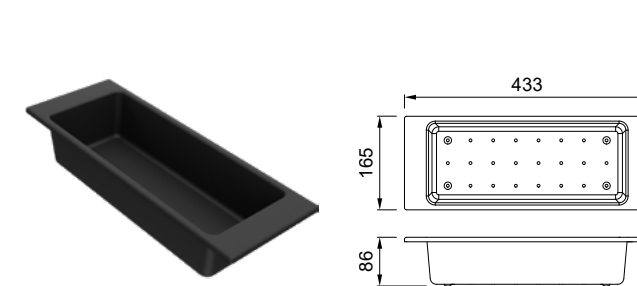

DIMENSIONI / DIMENSIONS
433 x 165 x 86 mm

FINITURE / FINISHES

- BK Black AVP037BK

Bowl 433

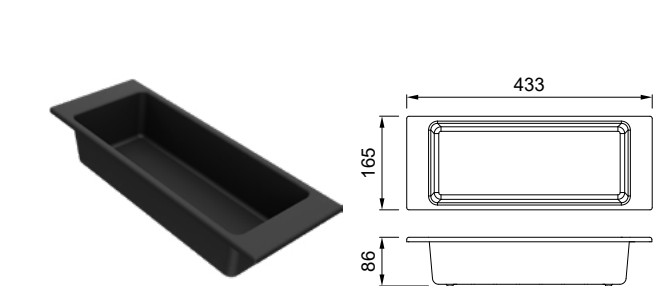

DIMENSIONI / DIMENSIONS
433 x 165 x 86 mm

FINITURE / FINISHES

- BK Black ABP037BK

Sintesi ACCESSORIES

Pod 250

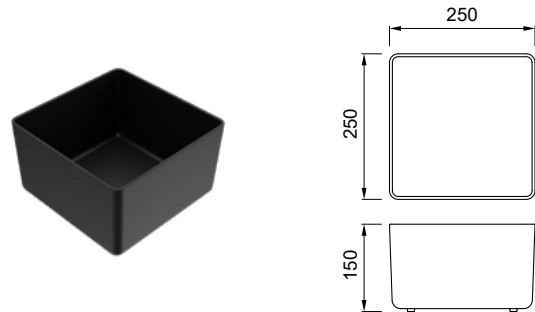

Contenitore multiuso in silicone
Silicon multi-use pod

DIMENSIONI / DIMENSIONS
250 x 250 x 150 mm

FINITURE / FINISHES

- BK Black
APS250BK
- K82 Sage
APS250SG
- K83 Clay
APS250CL

Gourmet Drain Silicon 433 1/6

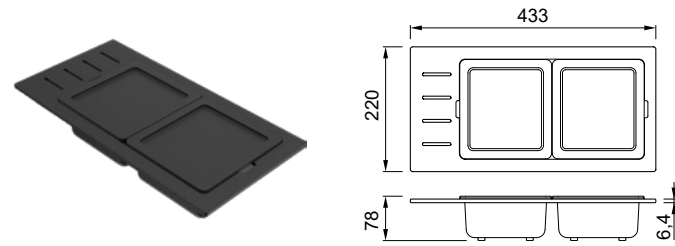

Struttura in Woodtech e vaschette con coperchio in silicone
Woodtech frame and silicon trays with cover

DIMENSIONI / DIMENSIONS
433 x 220 x 78 mm

FINITURE / FINISHES

- BK Black
KD012078BKSIL

Gourmet Drain 433 1/3

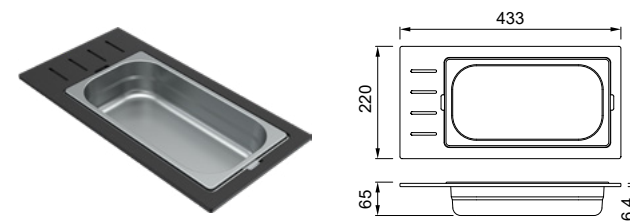

Struttura in Woodtech e vaschetta in acciaio Inox
Woodtech frame and stainless steel tray

DIMENSIONI / DIMENSIONS
433 x 220 x 65 mm

FINITURE / FINISHES

- IN Inox
KD011065IN
- BK Black
KD011065BK
- GD Gold
KD011065GD
- BZ Bronze
KD011065BZ

Gourmet Drain 433 1/6

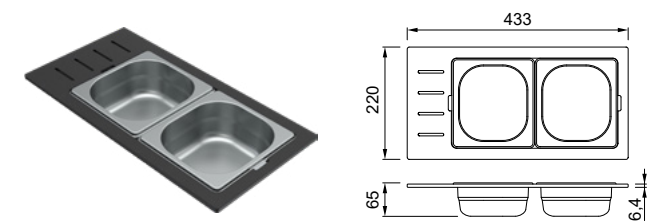

Struttura in Woodtech e vaschette in acciaio Inox
Woodtech frame and stainless steel trays

DIMENSIONI / DIMENSIONS
433 x 220 x 65 mm

FINITURE / FINISHES

- IN Inox
KD012065IN
- BK Black
KD012065BK
- GD Gold
KD012065GD
- BZ Bronze
KD012065BZ

Pod 162



Contenitore multiuso in silicone con coperchio
Silicon pod with cap

DIMENSIONI / DIMENSIONS
162 x 175 x 78 mm

FINITURE / FINISHES

- BK Black
APS162BK

Drainer Flex 500

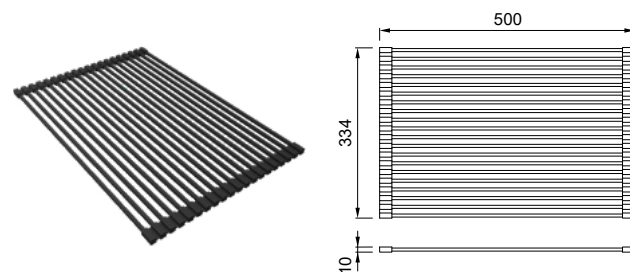

Gocciolatoio flessibile in silicone con barre in acciaio rivestite
Flexible drainer in silicon with steel-coated bars

DIMENSIONI / DIMENSIONS
500 x 334 x 10 mm

FINITURE / FINISHES

- BK Black
ARS023BK

Gourmet Drain 433 1/9

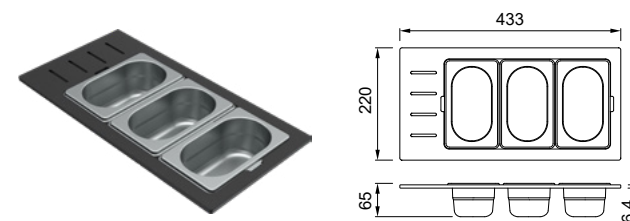

Struttura in Woodtech e vaschette in acciaio Inox
Woodtech frame and stainless steel trays

DIMENSIONI / DIMENSIONS
433 x 220 x 65 mm

FINITURE / FINISHES

- IN Inox
KD013065IN
- BK Black
KD013065BK
- GD Gold
KD013065GD
- BZ Bronze
KD013065BZ

Sintesi

Sintesi 130

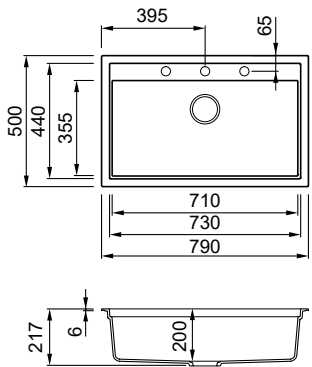

LAVELLO / SINK
Lavello 1 vasca - Non reversibile /
1-bowl sink - Non reversible

BASE / BASE
800 mm

DIMENSIONI / DIMENSIONS
790 x 500 mm - P D 200 mm

INCASSO / BUILT-IN
Sopratop / Inset = 770 x 480 mm
Filotop / Flushmount = consultare disegno
approfondito / see technical drawing

KERATEK

K86 BLACK	IN LKS13086	K83 CLAY	IN LKS13083
BK LKS13086BKM	BK LKS13083BKM	GD LKS13086GLD	GD LKS13083GLD
GD LKS13086GLD	BZ LKS13083BRZ	BZ LKS13086BRZ	BZ LKS13083BRZ
K99 DARK GREY	IN LKS13099	K82 SAGE	IN LKS13082
BK LKS13099BKM	BK LKS13082BKM	GD LKS13099GLD	GD LKS13082GLD
GD LKS13099GLD	BZ LKS13082BRZ	BZ LKS13099BRZ	BZ LKS13082BRZ
K96 WHITE	IN LKS13096	K87 COCOA	IN LKS13087
BK LKS13096BKM	BK LKS13087BKM	GD LKS13096GLD	GD LKS13087GLD
GD LKS13096GLD	BZ LKS13087BRZ	BZ LKS13096BRZ	BZ LKS13087BRZ

CORREDO / SINK KIT
Sifone salvaspazio, Flow Pro, Troppopieno rettangolare, Kit di fissaggio.
Space-saving siphon, Flow Pro waste, Rectangular Overflow, Fixing Kit.

Sintesi 105

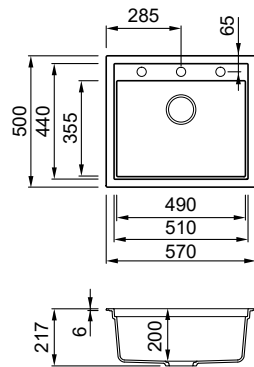

LAVELLO / SINK
Lavello 1 vasca - Non reversibile /
1-bowl sink - Non reversible

BASE / BASE
600 mm

DIMENSIONI / DIMENSIONS
570 x 500 mm - P D 200 mm

INCASSO / BUILT-IN
Sopratop / Inset = 550 x 480 mm
Filotop / Flushmount = consultare disegno
approfondito / see technical drawing

KERATEK

K86 BLACK	IN LKS10586	K83 CLAY	IN LKS10583
BK LKS10586BKM	BK LKS10583BKM	GD LKS10586GLD	GD LKS10583GLD
GD LKS10586GLD	BZ LKS10583BRZ	BZ LKS10586BRZ	BZ LKS10583BRZ
K99 DARK GREY	IN LKS10599	K82 SAGE	IN LKS10582
BK LKS10599BKM	BK LKS10582BKM	GD LKS10599GLD	GD LKS10582GLD
GD LKS10599GLD	BZ LKS10582BRZ	BZ LKS10599BRZ	BZ LKS10582BRZ
K96 WHITE	IN LKS10596	K87 COCOA	IN LKS10587
BK LKS10596BKM	BK LKS10587BKM	GD LKS10596GLD	GD LKS10587GLD
GD LKS10596GLD	BZ LKS10587BRZ	BZ LKS10596BRZ	BZ LKS10587BRZ

COMPONENTI / COMPONENTS
Overflow Rettangolare, Flow Pro

FINITURE / FINISHES
IN Inox, BK Black, GD Gold, BZ Bronze

Sintesi ACCESSORIES

Flow Pro Open Up

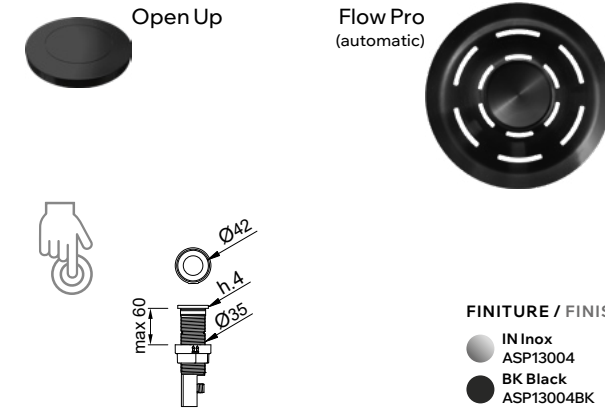

FINITURE / FINISHES
IN Inox ASP13004
BK Black ASP13004BK
GD Gold ASP13004GD
BZ Bronze ASP13004BZ

Sistema di scarico 1 via Flow Pro con comando remoto Open Up
1-way automatic Flow Pro drainer system with Open Up remote control
DIMENSIONE / DIMENSIONS
Ø 42

Flow Pro Open Twist

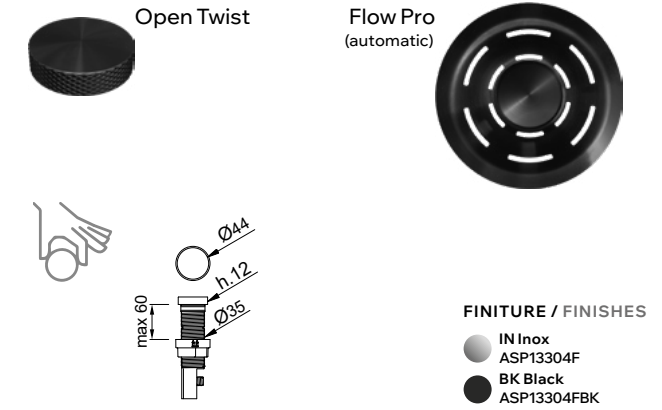

FINITURE / FINISHES
IN Inox ASP13304F
BK Black ASP13304FBK
GD Gold ASP13304FGD
BZ Bronze ASP13304FBZ

Sistema di scarico 1 via Flow Pro con comando remoto Open Twist
1-way automatic Flow Pro drainer system with Open Twist remote control
DIMENSIONE / DIMENSIONS
Ø 44

Chopping Board 500

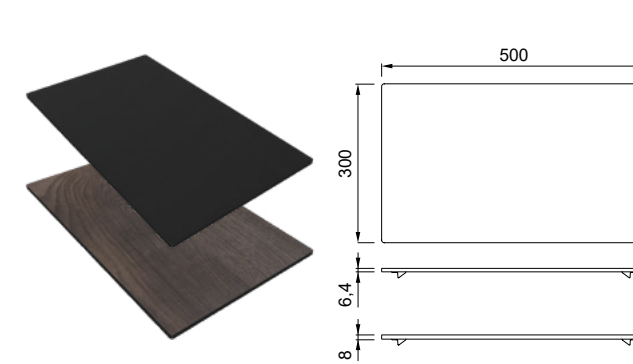

Tagliere in Woodtech / HPL
Chopping board in Woodtech / HPL

DIMENSIONI / DIMENSIONS
500 x 300 x 6,4 mm - fin. BK Black
500 x 300 x 8 mm - fin. WD Wood
Consigliato solo per Sintesi 130
Recommended only for Sintesi 130

FINITURE / FINISHES
BK Black ATH093BK
WD Wood ATH093WD

Soap Dispenser

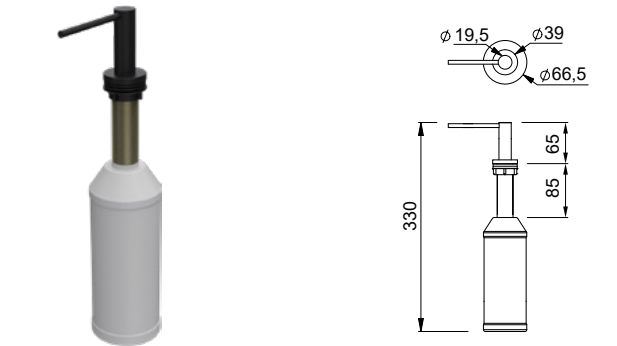

Dosatore sapone in metallo
Metal soap dispenser

DIMENSIONE FORO D'INCASSO / DIMENSIONS OF HOLE FOR BUILT-IN INSTALLATION
Ø 35
DIMENSIONE / DIMENSIONS
Ø 39

FINITURE / FINISHES
BK Black ADI02304BK
IN Inox ADI02304IN

Sintesi ACCESSORIES

Pod 250

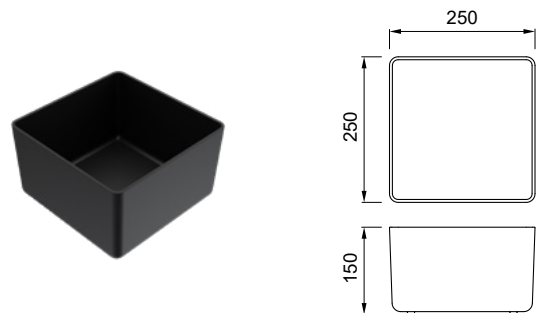

Contenitore multiuso in silicone
Silicon multi-use pod

DIMENSIONI / DIMENSIONS
250 x 250 x 150 mm

FINITURE / FINISHES

- BK Black
APS250BK
- K82 Sage
APS250SG
- K83 Clay
APS250CL

Gourmet Drain Silicon 366 1/6

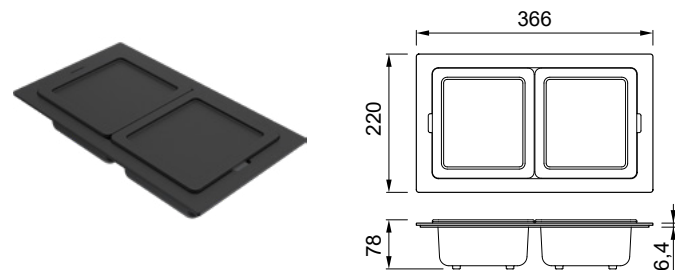

Struttura in Woodtech e vaschette con coperchio in silicone
Woodtech frame and silicon pods with cover

DIMENSIONI / DIMENSIONS
366 x 220 x 78 mm

FINITURE / FINISHES

- BK Black
KF012078BKSIL

Sintesi ACCESSORIES

Gourmet 366 1/3

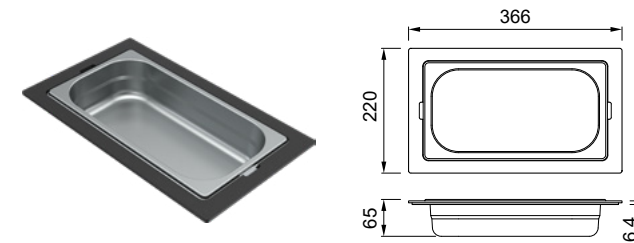

Struttura in Woodtech e vaschetta in acciaio Inox
Woodtech frame and stainless steel tray

DIMENSIONI / DIMENSIONS
366 x 220 x 65 mm

FINITURE / FINISHES

- IN Inox
KF011065IN
- BK Black
KF011065BK
- GD Gold
KF011065GD
- BZ Bronze
KF011065BZ

Gourmet 366 1/6

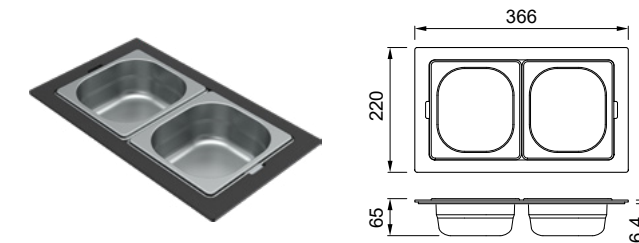

Struttura in Woodtech e vaschette in acciaio Inox
Woodtech frame and stainless steel trays

DIMENSIONI / DIMENSIONS
366 x 220 x 65 mm

FINITURE / FINISHES

- IN Inox
KF012065IN
- BK Black
KF012065BK
- GD Gold
KF012065GD
- BZ Bronze
KF012065BZ

Pod 162



Contenitore multiuso in silicone con coperchio
Silicon pod with cap

DIMENSIONI / DIMENSIONS
162 x 175 x 78 mm

FINITURE / FINISHES

- BK Black
APS162BK

Chopping Board 366

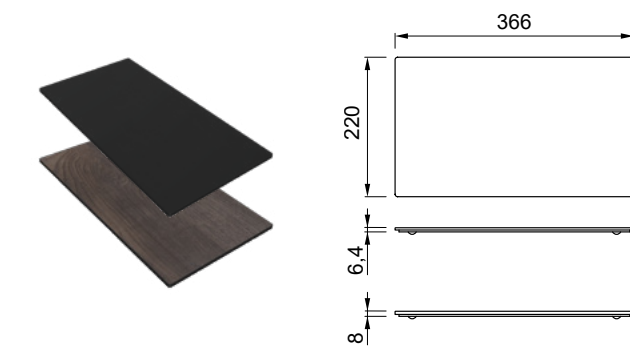

Tagliere in Woodtech / HPL
Chopping board in Woodtech / HPL

DIMENSIONI / DIMENSIONS
366 x 220 x 6,4 mm - fin. BK Black
366 x 220 x 8 mm - fin. WD Wood

FINITURE / FINISHES

- BK Black
ATH113BK
- WD Wood
ATH113WD

Gourmet 366 1/9

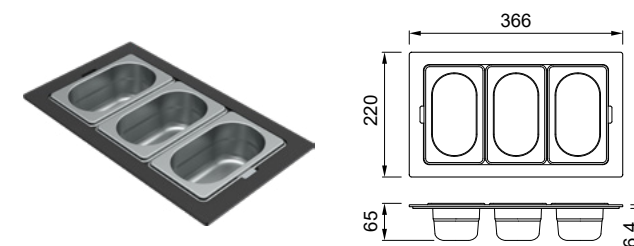

Struttura in Woodtech e vaschette in acciaio Inox
Woodtech frame and stainless steel trays

DIMENSIONI / DIMENSIONS
366 x 220 x 65 mm

FINITURE / FINISHES

- IN Inox
KF013065IN
- BK Black
KF013065BK
- GD Gold
KF013065GD
- BZ Bronze
KF013065BZ

Drainer Flex 500

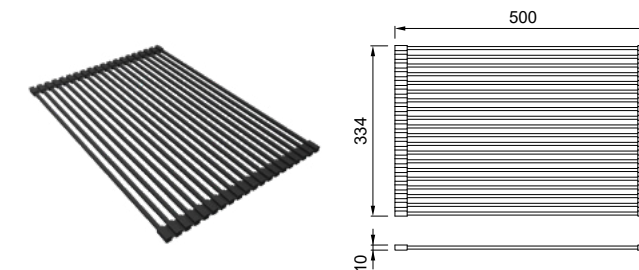

Gocciolatoio flessibile in silicone con barre in acciaio rivestite
Flexible drainer in silicone with steel-coated bars

DIMENSIONI / DIMENSIONS
500 x 334 x 10 mm
Consigliato solo per Sintesi 130
Recommended only for Sintesi 130

FINITURE / FINISHES

- BK Black
ARS023BK



Zen 105

BLACK

Forno termoventilato / Thermoventilated oven **Sipario**
 Forno microonde / Microwave oven **Sipario**
 Cassetto riscaldante / Warming drawer **Sipario**

Piano Induzione / Induction hob **Sipario 80**

Miscelatore / Tap **Carol Black**



Zen COLLECTION



SOPRATOP
INSET



SOTTOTOP
UNDERMOUNT



Il fascino dell'essenzialità si esprime in geometrie esemplari e nella perfezione simmetrica degli elementi. Zen è la collezione di vasche premium, nata per evocare il senso dell'equilibrio e della raffinatezza contemporanea, grazie alla personalità discreta quanto iconica.

Understated elegance showcased in exemplary shapes and the symmetrical perfection of the elements. Zen is the collection of premium sinks, created to evoke a sense of balance and contemporary elegance, thanks to its discrete yet iconic personality.

Caratteristiche / Features



SMART EDGE

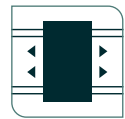

ACCESSORI SCORREVOLI
SLIDING ACCESSORIES



LAVELLO EXTRA-LARGE
EXTRA-LARGE BOWL



DETTAGLI DI STILE
STYLISH DETAILS

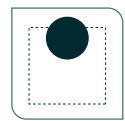

DESIGN MINIMAL
MINIMAL DESIGN



Lavello / Sink **Zen 105 Black**



Miscelatore / Tap **Carol Black**



Lavello / Sink Zen 102 Clay

Miscelatore / Tap Cross Black



Zen

COLLECTION



SOPRATOP
INSET



SOTTOTOP
UNDERMOUNT

I dettagli minimalisti delle vasche Zen consentono un facile posizionamento in differenti ambienti senza vincoli legati al materiale scelto. La trasversalità e l'eleganza senza tempo le rendono così la scelta perfetta per ogni esigenza.

Minimalist details of Zen bowls allow easy positioning in different environments. Transversality and timeless elegance make Zen collection the perfect choice for every need.

Caratteristiche / Features



SMART EDGE



ACCESSORI SCORREVOLI
SLIDING ACCESSORIES



LAVELLO EXTRA-LARGE
EXTRA-LARGE BOWL



DETTAGLI DI STILE
STYLISH DETAILS

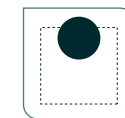

DESIGN MINIMAL
MINIMAL DESIGN



Zen F 130

C O C O A



- Forno Vapore / Steam oven **Sipario**
- Forno termoventilato / Thermoventilated oven **Sipario**
- Cantina / Wine cellar **Sipario**
- Forno pirolitico / Pyrolytic oven **Sipario**
- +
- Piano Aspirante / Extractor hob **Sipario**
- +
- Miscelatore / Tap **Hype Gold**



Zen F COLLECTION



**FILOTOP
FLUSHMOUNT**



Linee e forme in un continuum sensoriale. L'installazione filotop esalta il design puro ed essenziale del lavello, realizzando un'impeccabile continuità estetica con il piano. Zen F è la linea sinonimo di bellezza senza interruzioni, garanzia di precisione, armonia e leggerezza.

Lines and shapes in a streamlined sensory flow. The flush mount installation enhances the pure, simple design of the sink creating a seamless aesthetic flow with the countertop. Zen F is the line that showcases seamless beauty, guaranteeing precision, harmony and lightness.

Caratteristiche / Features



SMART EDGE



**ACCESSORI SCORREVOLI
SLIDING ACCESSORIES**



**LAVELLO EXTRA-LARGE
EXTRA-LARGE BOWL**



**DETTAGLI DI STILE
STYLISH DETAILS**

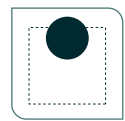

**DESIGN MINIMAL
MINIMAL DESIGN**



Lavello / Sink Zen 130 Cocoa

Miscelatore / Tap Hype Gold

Zen / Zen F ACCESSORIES

Possibili configurazioni
Possible configurations



Schema posizionamento accessori
Accessory placement diagram



Zen

Zen 102

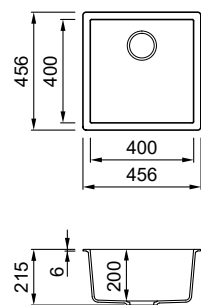

LAVELLO / SINK
1 Vasca - Non reversibile /
1 Bowl - Non reversible

DIMENSIONI / DIMENSIONS
456 x 456 mm - P D 200 mm

INCASSO / BUILT-IN
Sopratop / Inset = 445 x 445 R5 mm
Sottotop / Undermount = 400 x 400 R10 mm

**BASE SOPRATOP /
INSET BASE**
• 450 mm
• 500 mm se inizio
composizione /
if first component

**BASE SOTTOTOP /
UNDERMOUNT BASE**
500 mm

KERATEK



CORREDO / SINK KIT
Sifone salvaspazio, Flow Pro, Troppopieno rettangolare, Kit di fissaggio.
Space-saving siphon, Flow Pro waste, Rectangular Overflow, Fixing Kit.

Zen 105

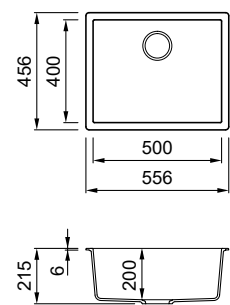

LAVELLO / SINK
1 Vasca - Non reversibile /
1 Bowl - Non reversible

DIMENSIONI / DIMENSIONS
556 x 456 mm - P D 200 mm

INCASSO / BUILT-IN
Sopratop / Inset = 545 x 445 R5 mm
Sottotop / Undermount = 500 x 400 R10 mm

BASE / BASE
600 mm

KERATEK



COMPONENTI / COMPONENTS
Overflow Rettangolare, Flow Pro

FINITURE / FINISHES
BK Black, GD Gold, BZ Bronze

Zen

Zen 130

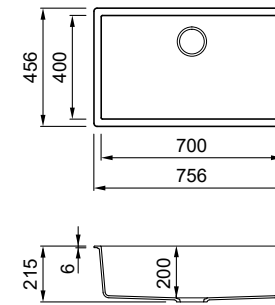

LAVELLO / SINK
1 Vasca - Non reversibile /
1 Bowl - Non reversible

DIMENSIONI / DIMENSIONS
756 x 456 mm - P D 200 mm

INCASSO / BUILT-IN
Sopratop / Inset = 745 x 445 R5 mm
Sottotop / Undermount = 700 x 400 R10 mm

BASE / BASE
800 mm

KERATEK



COMPONENTI / COMPONENTS
Overflow Rettangolare, Flow Pro

FINITURE / FINISHES
BK Black, GD Gold, BZ Bronze



Zen 150

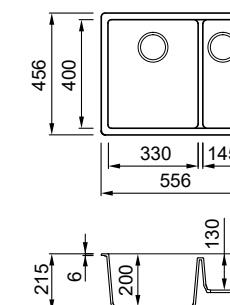

LAVELLO / SINK
1 Vasca e 1/2 - Non reversibile /
1 Bowl & 1/2 - Non reversible

DIMENSIONI / DIMENSIONS
556 x 456 mm - P D 200/130 mm

INCASSO / BUILT-IN
Sopratop / Inset = 545 x 445 R5 mm
Sottotop / Undermount = 500 x 400 R10 mm

BASE / BASE
600 mm

KERATEK



COMPONENTI / COMPONENTS
Overflow Rettangolare, Flow Pro

FINITURE / FINISHES
BK Black, GD Gold, BZ Bronze

Zen F



Zen F 102

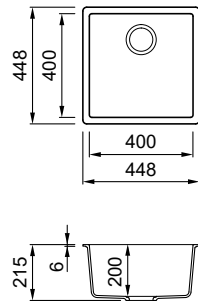

LAVELLO / SINK
1 Vasca - Non reversibile /
1 Bowl - Non reversible

BASE / BASE
500 mm

DIMENSIONI / DIMENSIONS
448 x 448 mm - P D 200 mm

INCASSO / BUILT-IN
Filotop / Flushmount = consultare disegno
approfondito / see technical drawing

KERATEK



Zen F 105

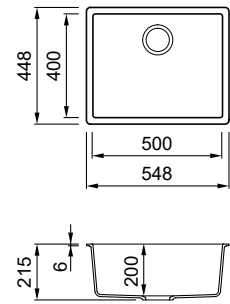

LAVELLO / SINK
1 Vasca - Non reversibile /
1 Bowl - Non reversible

BASE / BASE
600 mm

DIMENSIONI / DIMENSIONS
548 x 448 mm - P D 200 mm

INCASSO / BUILT-IN
Filotop / Flushmount = consultare disegno
approfondito / see technical drawing

KERATEK



Zen F



Zen F 130

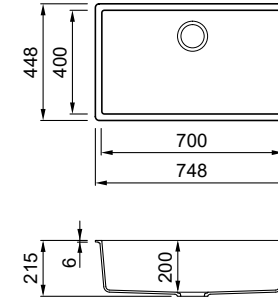

LAVELLO / SINK
1 Vasca - Non reversibile /
1 Bowl - Non reversible

BASE / BASE
800 mm

DIMENSIONI / DIMENSIONS
748 x 448 mm - P D 200 mm

INCASSO / BUILT-IN
Filotop / Flushmount = consultare disegno
approfondito / see technical drawing

KERATEK



Zen F 150

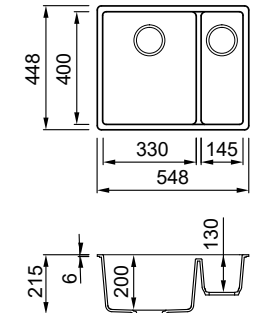

LAVELLO / SINK
1 Vasca e 1/2 - Non reversibile /
1 Bowl & 1/2 - Non reversible

BASE / BASE
600 mm

DIMENSIONI / DIMENSIONS
548 x 448 mm - P D 200 / 130 mm

INCASSO / BUILT-IN
Filotop / Flushmount = consultare disegno
approfondito / see technical drawing

KERATEK



CORREDO / SINK KIT
Sifone salvaspazio, Flow Pro, Troppopieno rettangolare, Kit di fissaggio.
Space-saving siphon, Flow Pro waste, Rectangular Overflow, Fixing Kit.

COMPONENTI / COMPONENTS
Overflow Rettangolare, Flow Pro

FINITURE / FINISHES
BK Black, GD Gold, BZ Bronze

Zen / Zen F ACCESSORIES

Chopping Board 418

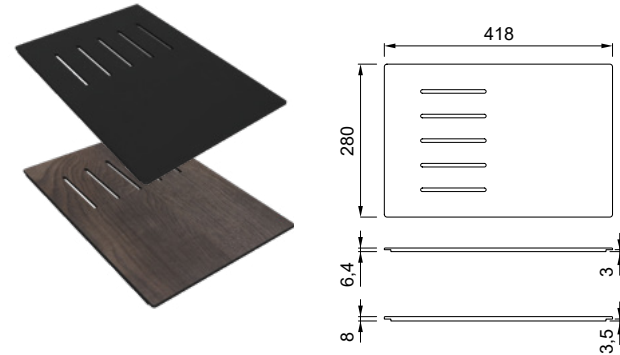

Tagliere in Woodtech / HPL
Chopping board in Woodtech / HPL

DIMENSIONI / DIMENSIONS
418 x 280 x 6,4 mm - fin. BK Black
418 x 280 x 8 mm - fin. WD Wood

FINITURE / FINISHES
● BK Black
ATH043BK
● WD Wood
ATH043WD

Drainer Flex 440

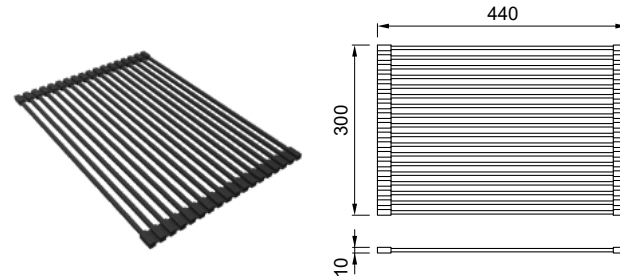

Gocciolatoio flessibile con barre in acciaio rivestite in silicone
Flexible drainer with silicon-coated steel bars

DIMENSIONI / DIMENSIONS
440 x 300 x 10 mm

FINITURE / FINISHES
● BK Black
ARS013BK

Colander 418

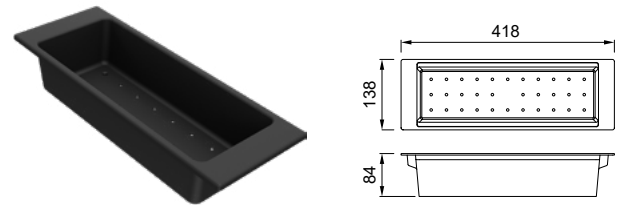

Vasca forata in polipropilene
Polypropylene colander

DIMENSIONI / DIMENSIONS
418 x 138 x 84 mm

FINITURE / FINISHES
● BK Black
AVP035BK

Zen / Zen F ACCESSORIES

Pod 250

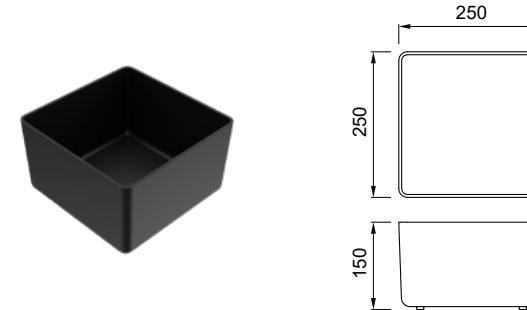

Contenitore multiuso in silicone
Silicon multi-use pod

DIMENSIONI / DIMENSIONS
250 x 250 x 150 mm

FINITURE / FINISHES
● BK Black
APS250BK
● K82 Sage
APS250SG
● K83 Clay
APS250CL

Gourmet Silicon 418 1/6

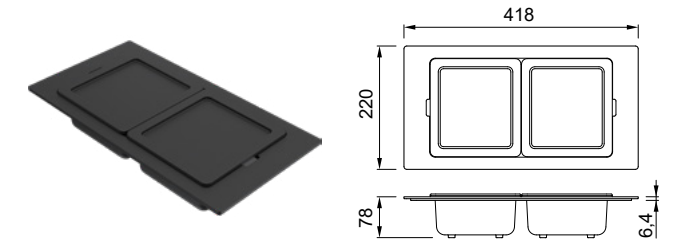

Struttura in Woodtech e vaschette con coperchio in silicone
Woodtech frame and silicon trays with cap

DIMENSIONI / DIMENSIONS
418 x 220 x 78 mm

FINITURE / FINISHES
● BK Black
KF042078BKSIL

Pod 162



Contenitore multiuso in silicone con coperchio
Silicon pod with cap

DIMENSIONI / DIMENSIONS
162 x 175 x 78 mm

FINITURE / FINISHES
● BK Black
APS162BK

Zen / Zen F ACCESSORIES

Gourmet 418 1/3

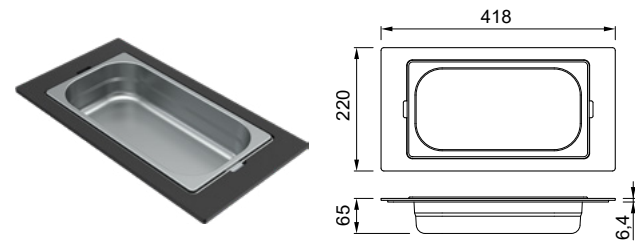

Struttura in Woodtech e vaschetta in acciaio Inox
Woodtech frame and stainless steel tray

DIMENSIONI / DIMENSIONS
418 x 220 x 65 mm

FINITURE / FINISHES

- IN Inox
KF041065IN
- BK Black
KF041065BK
- GD Gold
KF041065GD
- BZ Bronze
KF041065BZ

Gourmet 418 1/6

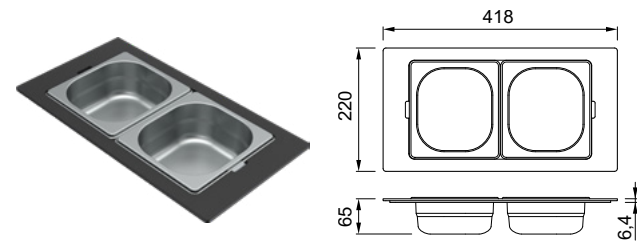

Struttura in Woodtech e vaschette in acciaio Inox
Woodtech frame and stainless steel trays

DIMENSIONI / DIMENSIONS
418 x 220 x 65 mm

FINITURE / FINISHES

- IN Inox
KF042065IN
- BK Black
KF042065BK
- GD Gold
KF042065GD
- BZ Bronze
KF042065BZ

Gourmet 418 1/9

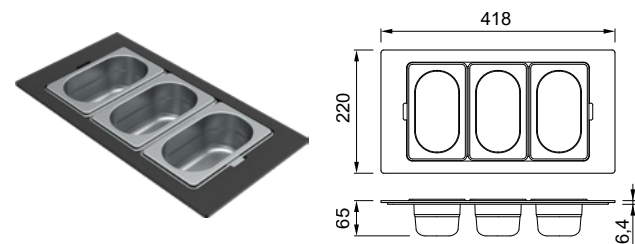

Struttura in Woodtech e vaschette in acciaio Inox
Woodtech frame and stainless steel trays

DIMENSIONI / DIMENSIONS
418 x 220 x 65 mm

FINITURE / FINISHES

- IN Inox
KF043065IN
- BK Black
KF043065BK
- GD Gold
KF043065GD
- BZ Bronze
KF043065BZ





Integra 130

BLACK

KITCHEN

Forno pirolitico / Pyrolytic oven **Sipario**

Piano Induzione 80 / Induction hob 80 **Sipario**

Miscelatore / Tap **Wave Black**

KITCHEN



Integra

COLLECTION



INTEGRATO
INTEGRATED



L'estetica evolve verso soluzioni di integrazione assoluta tra vasca e top. Materiali differenti, pregiati e performanti, vivono in un corpo unico: design, ergonomia e funzionalità si fondono per dare vita a uno spazio continuo di straordinario impatto estetico.

Visual appeal evolves towards complete integration between the sink and countertop. Different, elegant, high-performance materials are brought together in a single body: design, ergonomics and functionality are merged to create a seamless space with a strong visual impact.

Caratteristiche / Features

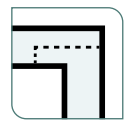

GIUNZIONE INVISIBILE
INVISIBLE JUNCTIONS



DETTAGLI DI STILE
STYLISH DETAILS

Nota tecnica. L'installazione delle vasche Integra necessita dell'intervento di operatori specializzati in soluzioni integrate con i piani di lavoro.

Technical note. Integra sinks must be installed by operators who are specialised in solutions integrated with the worktops.



Lavello / Sink **Integra 130 Black**



Miscelatore / Tap **Wave Black**

Integra 350 WHITE

KITCHEN

KITCHEN

Forno termoventilato / Termoventilated oven **Sipario**

Piano Induzione 60 / Induction hob 60 **Sipario**

Miscelatore / Tap **Stream Plus Gold**



Integra

COLLECTION



INTEGRATO
INTEGRATED



Bellezza monolitica e sapienza cromatica disegnano l'anima di Integra. Una collezione sartoriale di vasche, concepita per valorizzare l'incontro con superfici prestigiose attraverso giunzioni invisibili e raggi minimal, paradigma di creatività stilistica e maestria costruttiva.

The beauty of a monolith and the expert use of colour lie at the heart of Integra. A tailored collection of sinks, designed to enhance the encounter with elegant surfaces through invisible joints and minimal lines, a combination of stylistic creativity and expert craftsmanship.

Caratteristiche / Features

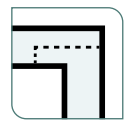

GIUNZIONE INVISIBILE
INVISIBLE JOINTS



DETTAGLI DI STILE
STYLISH DETAILS

Nota tecnica. L'installazione delle vasche Integra necessita dell'intervento di operatori specializzati in soluzioni integrate con i piani di lavoro.

Technical note. Integra sinks must be installed by operators who are specialised in solutions integrated with the worktops.



Lavello / Sink Integra 350 White

Miscelatore / Tap Stream Plus Gold

Integra ACCESSORIES

Possibili configurazioni
Possible configurations



Schema posizionamento accessori
Accessory placement diagram

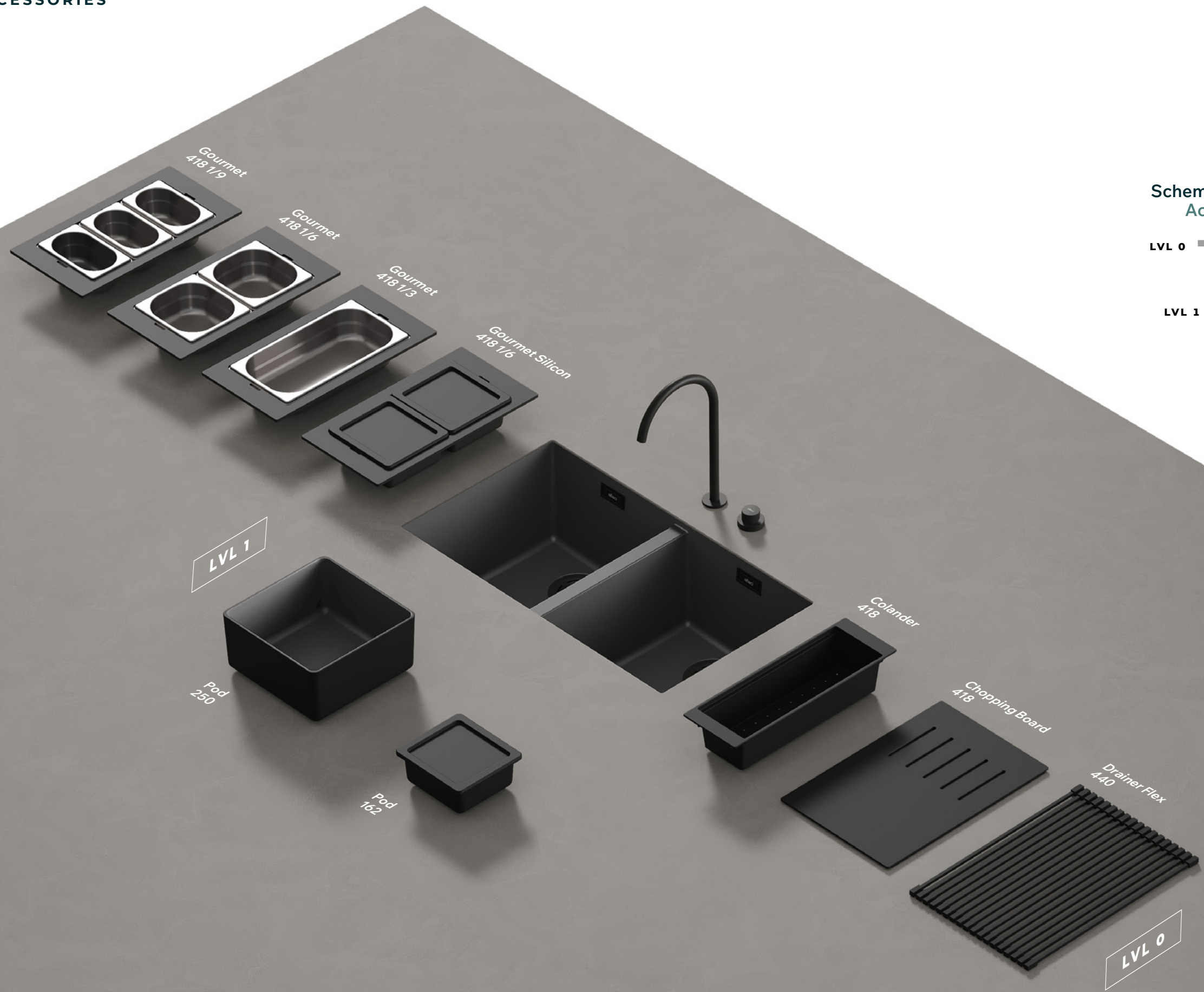

Gourmet
418 1/9

Gourmet
418 1/6

Gourmet
418 1/3

Gourmet Silicon
418 1/6

LVL 1

Pod
250

Pod
162

Colander
418

Chopping Board
418

Drainer Flex
440

LVL 0

Integra



Integra 102

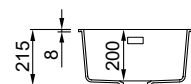
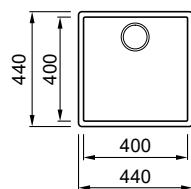

LAVELLO / SINK
1 Vasca - Non reversibile /
1 Bowl - Non reversible

BASE / BASE
500 mm

DIMENSIONI / DIMENSIONS
440 x 440 mm - P D 200 mm

INCASSO / BUILT-IN
400 x 400 R5 mm

KERATEK



Integra 105

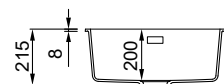
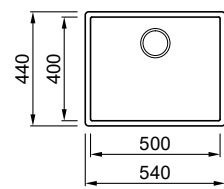

LAVELLO / SINK
1 Vasca - Non reversibile /
1 Bowl - Non reversible

BASE / BASE
600 mm

DIMENSIONI / DIMENSIONS
540 x 440 mm - P D 200 mm

INCASSO / BUILT-IN
500 x 400 R5 mm

KERATEK



Integra



Integra 130

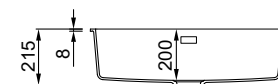
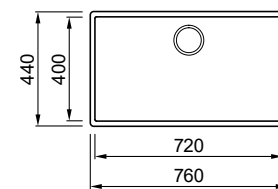

LAVELLO / SINK
1 Vasca - Non reversibile /
1 Bowl - Non reversible

BASE / BASE
800 mm

DIMENSIONI / DIMENSIONS
760 x 440 mm - P D 200 mm

INCASSO / BUILT-IN
720 x 400 R5 mm

KERATEK



Integra 350

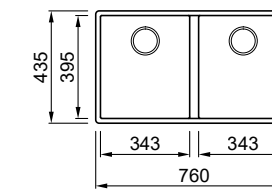

LAVELLO / SINK
2 Vasche - Non reversibile /
2 Bowls - Non reversible

BASE / BASE
800 mm

DIMENSIONI / DIMENSIONS
760 x 435 mm - P D 220 mm

INCASSO / BUILT-IN
720 x 395 R5 mm

KERATEK



CORREDO / SINK KIT

Sifone salvaspazio, Flow Pro, Troppopieno rettangolare, Kit di fissaggio.
Space-saving siphon, Flow Pro waste, Rectangular Overflow, Fixing Kit.

COMPONENTI / COMPONENTS

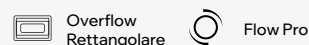

FINITURE / FINISHES



Integra ACCESSORIES

Chopping Board 418

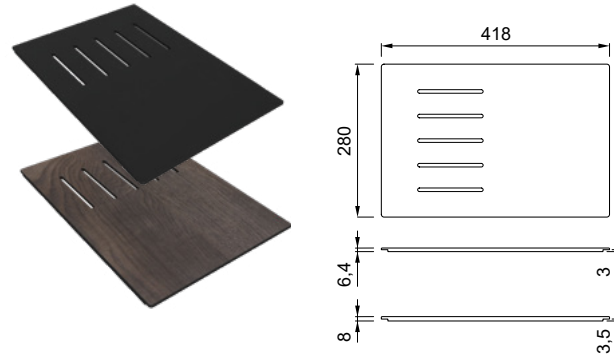

Tagliere in Woodtech / HPL
Chopping board in Woodtech / HPL

DIMENSIONI / DIMENSIONS
418 x 280 x 6,4 mm - fin. BK Black
418 x 280 x 8 mm - fin. WD Wood

FINITURE / FINISHES
● BK Black
ATH043BK
● WD Wood
ATH043WD

Drainer Flex 440

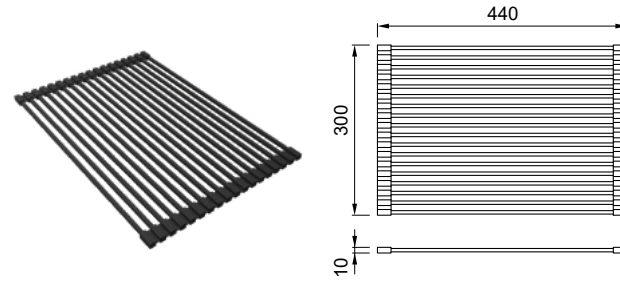

Gocciolatoio flessibile con barre in acciaio rivestite in silicone
Flexible drainer with silicon-coated steel bars

DIMENSIONI / DIMENSIONS
440 x 300 x 10 mm

FINITURE / FINISHES
● BK Black
ARS013BK

Colander 418

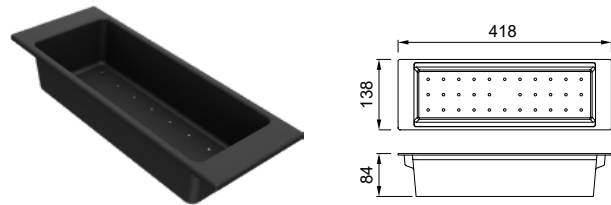

Vasca forata in polipropilene
Polypropylene colander

DIMENSIONI / DIMENSIONS
418 x 138 x 84 mm

FINITURE / FINISHES
● BK Black
AVP035BK

Integra ACCESSORIES

Pod 250

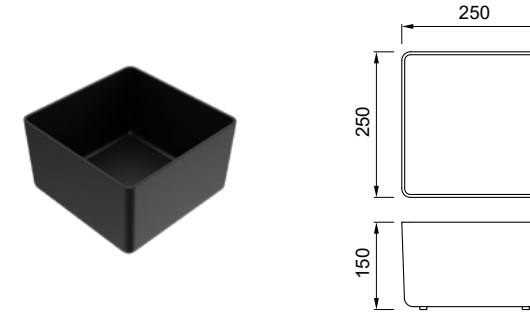

Contenitore multiuso in silicone
Silicon multi-use pod

DIMENSIONI / DIMENSIONS
250 x 250 x 150 mm

FINITURE / FINISHES
● BK Black
APS250BK
● K82 Sage
APS250SG
● K83 Clay
APS250CL

Gourmet Silicon 418

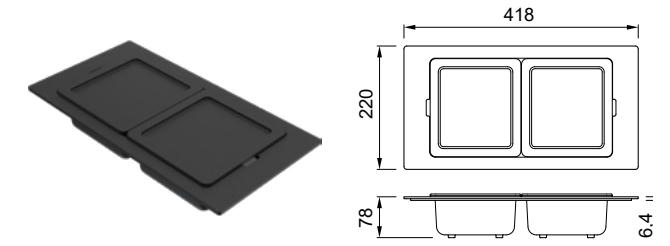

Struttura in Woodtech e vaschette con coperchio in silicone
Woodtech frame and silicon trays with cap

DIMENSIONI / DIMENSIONS
418 x 220 x 78 mm

FINITURE / FINISHES
● BK Black
KF042078BKSIL

Pod 162



Contenitore multiuso in silicone con coperchio
Silicon pod with cap

DIMENSIONI / DIMENSIONS
162 x 175 x 78 mm

FINITURE / FINISHES
● BK Black
APS162BK

Integra ACCESSORIES

Gourmet 418 1/3

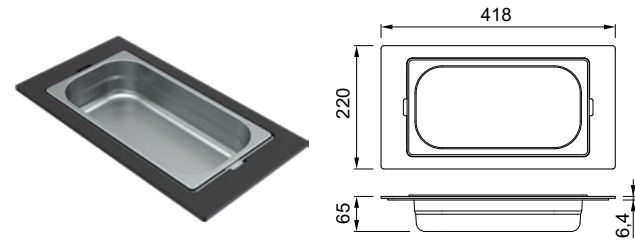

Struttura in Woodtech e vaschetta in acciaio Inox
Woodtech frame and stainless steel tray

DIMENSIONI / DIMENSIONS
418 x 220 x 65 mm

FINITURE / FINISHES

- IN Inox
KF041065IN
- BK Black
KF041065BK
- GD Gold
KF041065GD
- BZ Bronze
KF041065BZ

Gourmet 418 1/6

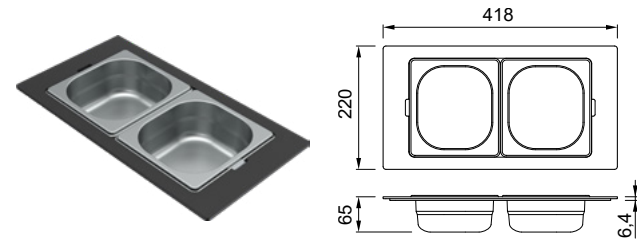

Struttura in Woodtech e vaschette in acciaio Inox
Woodtech frame and stainless steel trays

DIMENSIONI / DIMENSIONS
418 x 220 x 65 mm

FINITURE / FINISHES

- IN Inox
KF042065IN
- BK Black
KF042065BK
- GD Gold
KF042065GD
- BZ Bronze
KF042065BZ

Gourmet 418 1/9

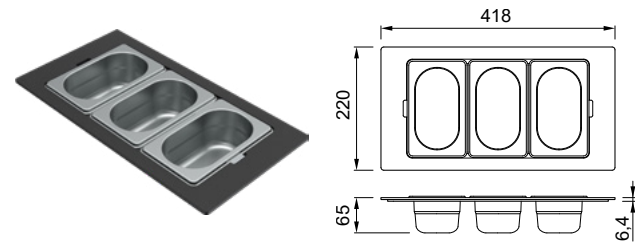

Struttura in Woodtech e vaschette in acciaio Inox
Woodtech frame and stainless steel trays

DIMENSIONI / DIMENSIONS
418 x 220 x 65 mm

FINITURE / FINISHES

- IN Inox
KF043065IN
- BK Black
KF043065BK
- GD Gold
KF043065GD
- BZ Bronze
KF043065BZ





Forno termoventilato / Thermoventilated oven **Sipario**
 Forno microonde / Microwave oven **Sipario**
 Cassetto riscaldante / Warming drawer **Sipario**

Piano gas 75 / Gas hob 75 **Sipario**

Miscelatore / Tap **Swan Black**

Essenza 70

BLACK



Essenza

COLLECTION

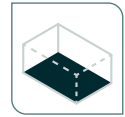

FONDO VASCA
TANK BOTTOM



Essenza è il fondo vasca in Keratek per lavelli costruiti in materiali nobili e compatti, che soddisfa l'architettura d'interni più sofisticata. Innumerevoli suggestioni estetiche nascono da abbinamenti cromatici tono su tono e a contrasto; design sublime e giunzioni perfette elevano la promessa di igiene e praticità d'uso.

Essenza is the Keratek sink bottom developed for bowls made of noble and compact materials that complements even the most sophisticated interior designs. A whole host of aesthetic solutions are possible thanks to tone-on-tone and contrasting colour combinations; the sublime design and seamless joints ensure hygiene and ease-of-use.

Caratteristiche / Features



ANGOLI INTERNI RAGGIATI
EDGELESS DESIGN



DETTAGLI DI STILE
STYLISH DETAILS

Nota tecnica. L'installazione del fondo vasca Essenza necessita dell'intervento di operatori specializzati in soluzioni integrate con i piani di lavoro.

Technical note. Essenza sink base liner must be installed by operators who are specialised in solutions integrated with the worktops.



Essenza



Essenza 70

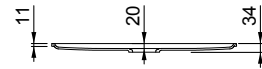
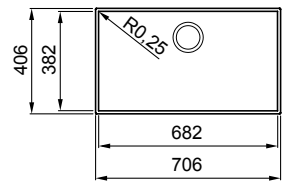

LAVELLO / SINK
1 Vasca - Reversibile / 1 Bowl - Reversible

BASE / BASE
800 mm

DIMENSIONI / DIMENSIONS
706 x 406 mm - P D 20 mm

KERATEK

- K86 BLACK**
 - IN LKES7086
 - BK LKES7086BKM
 - GD LKES7086GLD
 - BZ LKES7086BRZ
- K99 DARK GREY**
 - IN LKES7099
 - BK LKES7099BKM
 - GD LKES7099GLD
 - BZ LKES7099BRZ
- K96 WHITE**
 - IN LKES7096
 - BK LKES7096BKM
 - GD LKES7096GLD
 - BZ LKES7096BRZ

Essenza 50

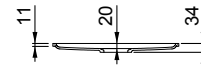
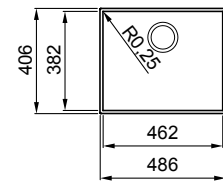

LAVELLO / SINK
Accessorio 1 vasca / 11 Accessory sink

BASE / BASE
600 mm

DIMENSIONI / DIMENSIONS
486 x 406 mm - P D 20 mm

KERATEK

- K86 BLACK**
 - IN LKES5086
 - BK LKES5086BKM
 - GD LKES5086GLD
 - BZ LKES5086BRZ
- K99 DARK GREY**
 - IN LKES5099
 - BK LKES5099BKM
 - GD LKES5099GLD
 - BZ LKES5099BRZ
- K96 WHITE**
 - IN LKES5096
 - BK LKES5096BKM
 - GD LKES5096GLD
 - BZ LKES5096BRZ

CORREDO / SINK KIT
Sifone salvaspazio, Flow Pro, Troppopieno rettangolare, Kit di fissaggio.
Space-saving siphon, Flow Pro waste, Rectangular Overflow, Fixing Kit.

COMPONENTI / COMPONENTS
 Overflow Rettangolare Flow Pro

FINITURE / FINISHES
 IN Inox GD Gold
 BK Black BZ Bronze

Essenza ACCESSORIES

Pod 250

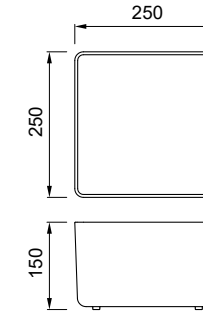

Contenitore multiuso in silicone
Silicon multi-use pod

DIMENSIONI / DIMENSIONS
250 x 250 x 150 mm

FINITURE / FINISHES

- BK Black
- APS250BK
- K82 Sage
- APS250SG
- K83 Clay
- APS250CL

Pod 162

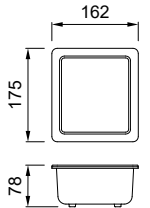
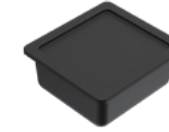

Contenitore multiuso in silicone con coperchio
Silicon pod with cap

DIMENSIONI / DIMENSIONS
162 x 175 x 78 mm

FINITURE / FINISHES

- BK Black
- APS162BK

Montaggio / Assembly

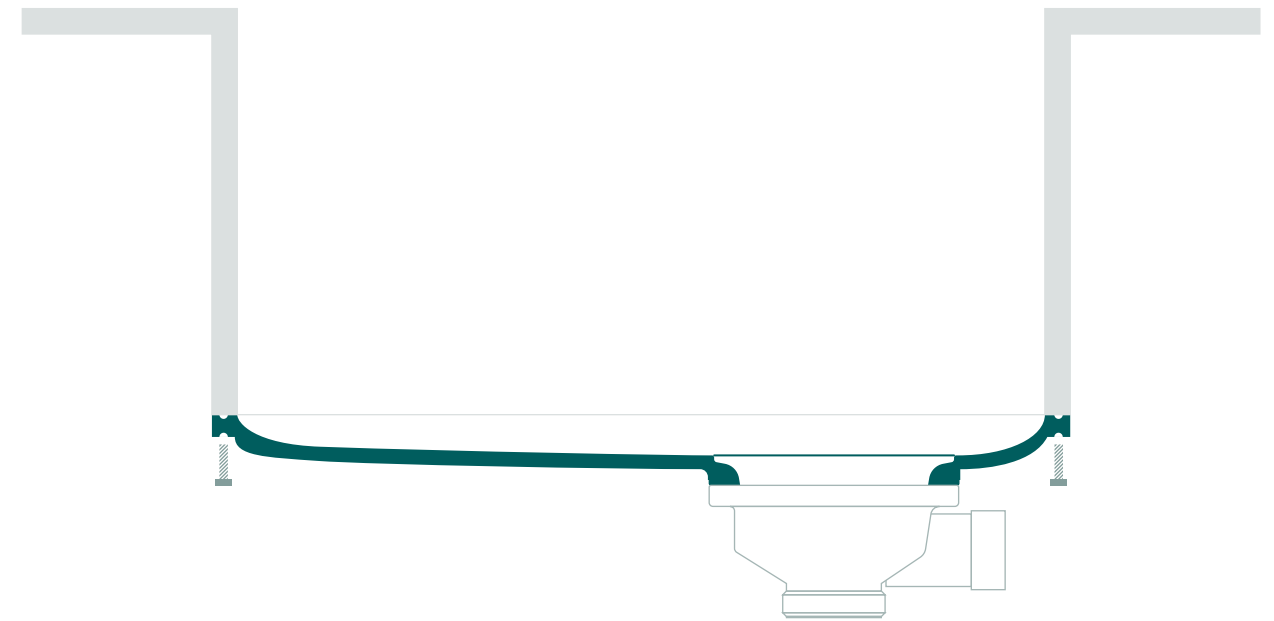

Miscelatori Taps



Flamingo
PURE

Carol
PURE

Cross
PURE

Fold

Swan

Arch

Baron

Smith



Bahia

Wave

Eclipse

Hype

Trail

Club

Stream
PLUS

elleci pure

Il sistema di purificazione dell'acqua multistadio all-in-one e pronto all'uso

Il processo di filtrazione combina azioni diverse, riuscendo ad abbattere le sostanze nocive presenti nel sistema idrico e a migliorare il gusto dell'acqua come mai prima d'ora. Dimensioni compatte, organizzazione e sensibilità estetica delineano i tratti distintivi dell'**Elleci Pure Case**. Due programmi evoluti, **Micro-filtrazione e Ultra-filtrazione**, offrono la soluzione più performante in base alla struttura dell'acqua in ingresso*. La famiglia di **Miscelatori Elleci Pure** aggiunge alla funzionalità filtrante il piacere di un design ricercato.

** Il sistema di purificazione è efficace esclusivamente con acqua potabile. Per scegliere il programma di filtrazione più adatto alle proprie esigenze, si consiglia di effettuare analisi dell'acqua in ingresso.*

ACQUA PURA

Niente batteri, virus, metalli pesanti, microplastiche e residui tossici

GUSTO PIACEVOLE

Eliminazione delle sostanze che alterano odore e sapore dell'acqua

RISPETTO DELL'AMBIENTE

Sensibile riduzione del consumo di plastica e delle emissioni di CO₂

COMODITÀ

Fine dell'impegno per acquisto, trasporto e stoccaggio delle bottiglie

AUTONOMIA

Sistema pronto all'uso e di facile manutenzione per ricambio filtri

ESTETICA

Design curato, installazione discreta, abbinamento con miscelatori Élite Kitchen

The ready-to-use, multi-stage, all-in-one water purification system

Compact sizes, organisation and visual appeal are the hallmark features of **Elleci Pure Case** that houses all the functional components. Two advanced **Micro-filtration and Ultra-filtration** programmes deliver the best solution depending on the structure of the mains water*. The family of **Elleci Pure taps** adds visual appeal of a sophisticated design to the choice between mixed and filtered water.

** The purification system only works with drinking water. In order to choose the most suitable filtration programme for your needs, we recommend carrying out an analysis of your mains water.*

PURE WATER

Say goodbye to bacteria, heavy metals, micro-plastics and harmful residue

PLEASANT TASTE

Elimination of the substances that change the smell and taste of water

ENVIRONMENTALLY FRIENDLY

Noticeable reduction in the consumption of plastic and CO₂ emissions

CONVENIENT

No more buying, transporting and storing bottles

AUTONOMY

Ready-to-use system with easy filter change maintenance

VISUAL APPEAL

Elegant design, discrete installation, paired with Élite Kitchen taps



Elleci Pure Case

Installazione facile, attivazione plug and play
Easy installation, plug and play activation

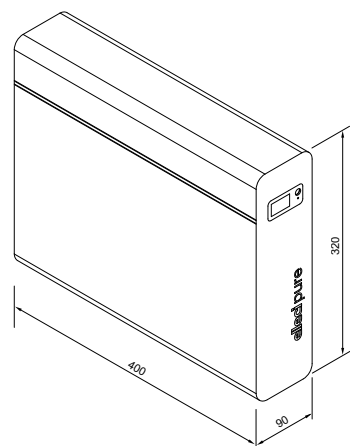

Elleci Pure Case

- Dimensioni compatte
- Attivazione "plug and play"
- Accesso facilitato per ricambio filtri
- Display digitale contalitri
- Sensore di sicurezza antiallagamento
- Alimentazione display a batteria di lunga durata
- Non necessita di alimentazione elettrica
- Compact sizes
- "Plug and play" activation
- Easy access for filter change
- Digital consumption display
- Flood detection safety sensor
- Long-life battery power supply
- Does not require a power supply

Elleci Pure Tap

- Leva acqua corrente miscelata
- Comando ergonomico acqua filtrata naturale
- Canali di erogazione separati per acqua miscelata e acqua filtrata
- Mixed running water lever
- Ergonomic natural filtered water control
- Separate inlets for mixed water and filtered water

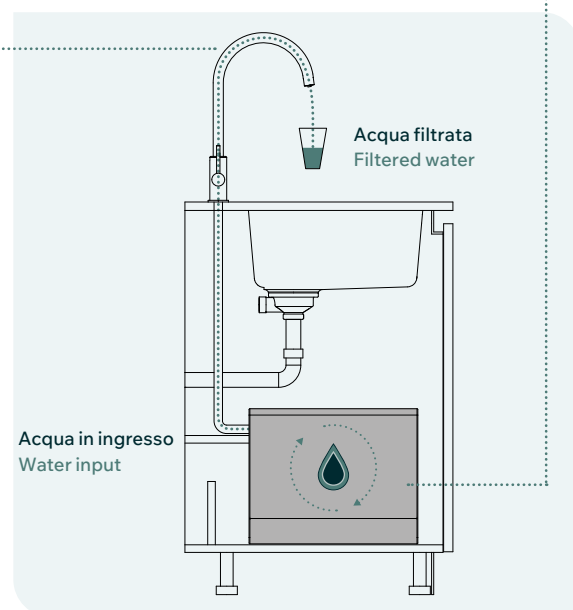

3 Installazioni salvaspazio Space-saving installation

Verticale
Interno base lavello

Vertical
Inside sink base unit

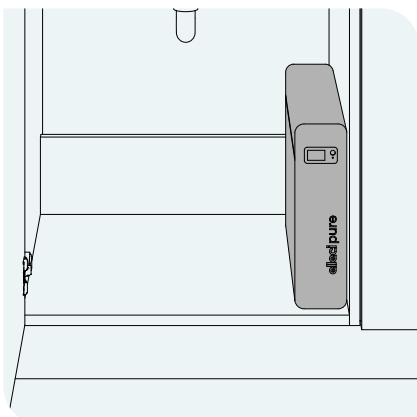

Orizzontale
Interno base lavello

Horizontal
Inside sink base unit

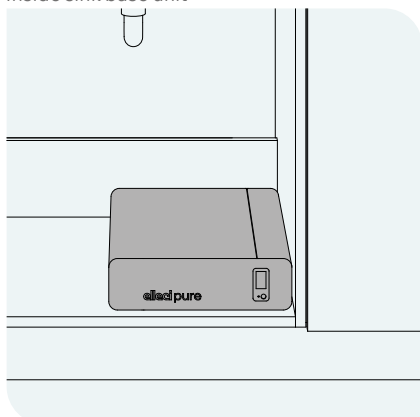

Orizzontale
Sotto zoccolo, H min. 10 cm

Horizontal
Under plinth, H min. 10 cm

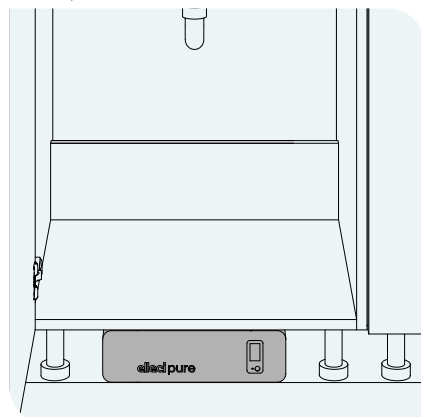

2 Programmi evoluti di filtrazione multistadio Advanced multi-stage filtration programmes



Pure case
ULTRA



BK Black
MOKCAUBK

Contiene n. 1 filtro sedimenti 5 micron+ n. 1 filtro multistadio 0,15 micron carboni attivi e sali d'argento. Autonomia 5.000 L/1 anno
Contains: n. 1 x 5 micron sediment filter + n. 1 x 0.15 micron active carbon and silver salts multistage filter, 5.000 L/1 year autonomy



Pure case
MICRO



BK Black
MOKCAMBK

Contiene n. 1 filtro multistadio 0,5 micron carboni attivi e sali d'argento. Autonomia 15.000 L/1 anno
Contains: n. 1 x 0.5 micron active carbon and silver salts multistage filter, 15.000 L/1 year autonomy

Filtrazione multistadio Multistage filtration			
0	Prefiltrazione 5 micron Prefiltration 5 microns	Riduce sedimenti e torbidità Reduces sediments and turbidity	
1	Ultra filtrazione 0,15 micron Ultra filtration 0.15 micron	Trattiene microparticelle, ruggine, muffa e alghe Holds microparticles, rust, mold and algae	1
2	Carboni attivi 100% sostenibili 100% sustainable activated carbons	Rimuove cloro, metalli e residui tossici Removes chlorine, metals and toxic residues	2
3	Sali d'argento Silver salts	Azione batteriostatica Bacteriostatic action	3
			1
			2
			3

Abbinabile a / Matching with

Flamingo pure
Miscelatore filtrante / Filtering tap



Carol pure
Miscelatore filtrante / Filtering tap



Cross pure
Miscelatore filtrante / Filtering tap

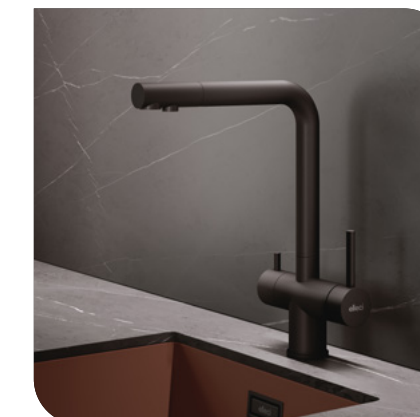



Flamingo PURE



FILTRANTE
FILTERING



3 VIE
(filtrata, calda, fredda)
3 FLOWS
(filtered, hot, cold)



COMANDO
COLORATO
COLORED
CONTROL



ROTAZIONE
CANNA
SPOUT ROTATION

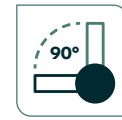

FUNZIONAMENTO
LEVA 0-90°
HANDLE ROT. 90°



COLORE UNICO
FULL COLOUR

+ Miscelatore filtrante con canna girevole
Filtering tap with rotating spout

FINITURE / FINISHES

● CS Cromo spazzolato
MIKFLMCS

● BK Black
MOKFLMBK

FINITURE LEVA / LEVER FINISHES

● Black K82 Sage
MOKFLMBK82

● Black K83 Clay
MOKFLMBK83

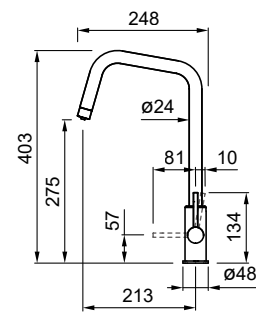

DIMENSIONE FORO / HOLE SIZE = \varnothing 35 mm

BASE / BASE = \varnothing 48 mm

ROTAZIONE CANNA / SPOUT ROTATION = 360°

FLESSIBILE / FLEXI-HOSE = Inox 3/8" - 430 mm

CARTUCCIA / CARTRIDGE = 25 mm



ABBINABILE A ELLECI PURE CASE /
MATCHABLE WITH CASE ELLECI PURE



Carol PURE



FILTRANTE
FILTERING



3 VIE
(filtrata, calda, fredda)
3 FLOWS
(filtered, hot, cold)



COMANDO
COLORATO
COLORED
CONTROL

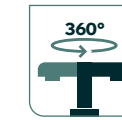

ROTAZIONE
CANNA
SPOUT ROTATION

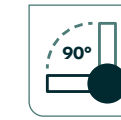

FUNZIONAMENTO
LEVA 0-90°
HANDLE ROT. 90°



COLORE UNICO
FULL COLOUR

+ Miscelatore filtrante con canna girevole
Filtering tap with rotating spout

FINITURE / FINISHES

● CS Cromo spazzolato
MIKCARCS

● BK Black
MOKCARBK

FINITURE LEVA / LEVER FINISHES

● Black K82 Sage
MOKCARBK82

● Black K83 Clay
MOKCARBK83

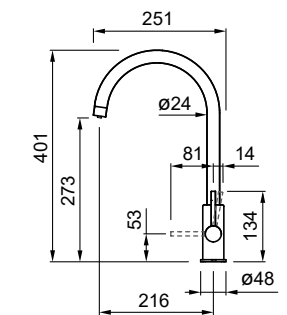

DIMENSIONE FORO / HOLE SIZE = \varnothing 35 mm

BASE / BASE = \varnothing 48 mm

ROTAZIONE CANNA / SPOUT ROTATION = 360°

FLESSIBILE / FLEXI-HOSE = Inox 3/8" - 430 mm

CARTUCCIA / CARTRIDGE = 25 mm



ABBINABILE A ELLECI PURE CASE /
MATCHABLE WITH CASE ELLECI PURE



Cross PURE



FILTRANTE
FILTERING



3 VIE
(filtrata, calda, fredda)
3 FLOWS
(filtered, hot, cold)



**DOCCETTA
ESTRAIBILE**
PULL-OUT
SPRAYER

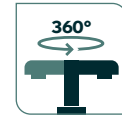

**ROTAZIONE
CANNA**
SPOUT ROTATION

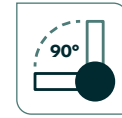

**FUNZIONAMENTO
LEVA 0-90°**
HANDLE ROT. 90°



COLORE UNICO
FULL COLOUR



Miscelatore filtrante con canna girevole e doccetta estraibile
Filtering tap with swivel spout and pull-out sprayer

FINITURE / FINISHES

● CS Cromo spazzolato
MIKCROCS

● BK Black
MOKCROBK

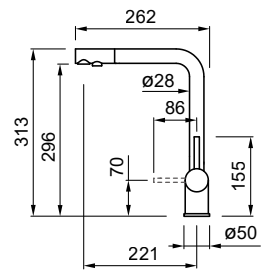

DIMENSIONE FORO / HOLE SIZE = \varnothing 35 mm

BASE / BASE = \varnothing 50 mm

ROTAZIONE CANNA / SPOUT ROTATION = 360°

FLESSIBILE / FLEXI-HOSE = Inox 3/8" - 400 mm

CARTUCCIA / CARTRIDGE = 35 mm



ABBINABILE A ELLECI PURE CASE /
MATCHABLE WITH CASE ELLECI PURE





Arch



COMANDO REMOTO
REMOTE CONTROL



**DOCCETTA
ESTRAIBILE**
PULL-OUT
SPRAYER

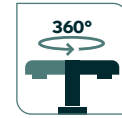

ROTAZIONE CANNA
SPOUT ROTATION





COLORE UNICO
FULL COLOUR



Miscelatore monocomando con canna girevole e comando remoto
Tap with pull-out sprayer and remote control

FINITURE / FINISHES

-  CS Cromo spazzolato
MIKARHCS
-  BK Black
MOKARHBK
-  GD Gold
MOKARHGD
-  BZ Bronze
MOKARHBZ

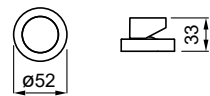
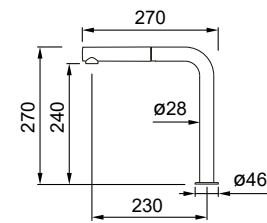

DIMENSIONE FORO CANNA / SPOUT HOLE SIZE = \varnothing 35 mm

DIMENSIONE FORO COMANDO / REMOTE HOLE SIZE = \varnothing 35 mm

BASE CANNA / BASE = \varnothing 46 mm

BASE COMANDO / BASE = \varnothing 52 mm

ROTAZIONE CANNA / SPOUT ROTATION = 360°

FLESSIBILE / FLEXI-HOSE = Inox 3/8" - 400 mm

CARTUCCIA / CARTRIDGE = 25 mm





Swan



COMANDO REMOTO
REMOTE CONTROL

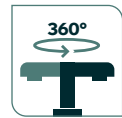

ROTAZIONE CANNA
SPOUT ROTATION



COLORE UNICO
FULL COLOUR

+ Miscelatore monocomando con canna girevole e comando remoto
Single-level tap with swivel spout and and remote control

FINITURE / FINISHES

● CS Cromo spazzolato
MIKSWACS

● BK Black
MOKSWABK

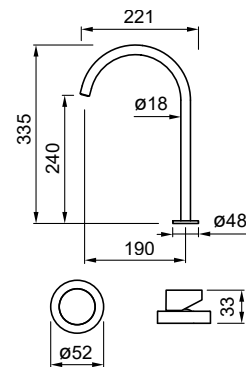

DIMENSIONE FORO CANNA / SPOUT HOLE SIZE = ø 35 mm
DIMENSIONE FORO COMANDO / REMOTE HOLE SIZE = ø 35 mm
BASE CANNA / SPOUT BASE = ø 48 mm
BASE COMANDO / REMOTE CONTROL BASE = ø 52 mm
ROTAZIONE CANNA / SPOUT ROTATION = 360°
FLESSIBILE / FLEXI-HOSE = Inox 3/8" - 450 mm
CARTUCCIA / CARTRIDGE = 25 mm

KITCHEN



Fold



COMANDO REMOTO
REMOTE CONTROL



ABBATTIBILE
TELESCOPIC



DOCCETTA
ESTRAIBILE
PULL-OUT
SPRAYER

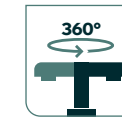

ROTAZIONE CANNA
SPOUT ROTATION



COLORE UNICO
FULL COLOUR

+ Miscelatore abbattibile monocomando con canna girevole, doccetta estraibile e comando remoto
Single-level telescopic tap with swivel spout, pull-out sprayer and remote control

FINITURE / FINISHES

● CS Cromo spazzolato
MIKFOLCS

● BK Black
MOKFOLBK

● GD Gold
MOKFOLGD

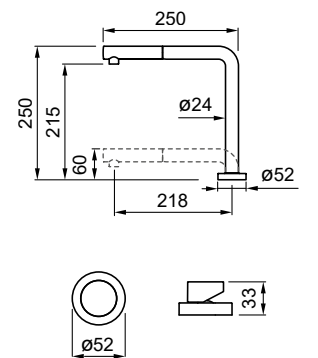

DIMENSIONE FORO CANNA / SPOUT HOLE SIZE = ø 35 mm
DIMENSIONE FORO COMANDO / REMOTE HOLE SIZE = ø 35 mm
BASE CANNA E COMANDO / SPOUT AND REMOTE CONTROL BASE = ø 52 mm
ROTAZIONE CANNA / SPOUT ROTATION = 360°
FLESSIBILE / FLEXI-HOSE = Inox 3/8" - 450 mm
CARTUCCIA / CARTRIDGE = 25 mm

KITCHEN



Baron



LEVA COLORATA
COLORED LEVER

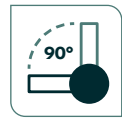

FUNZIONAMENTO
LEVA 0-90°
HANDLE ROT. 90°

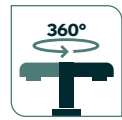

ROTAZIONE CANNA
SPOUT ROTATION



COLORE UNICO
FULL COLOUR

+ Miscelatore monocomando con canna girevole
Single-level tap with swivel spout

FINITURE / FINISHES

- CS Cromo spazzolato
MIKBARCS
- BK Black
MOKBARBK

FINITURE LEVA / LEVER FINISHES

- Black K82 Sage
MOKBARBK82
- Black K83 Clay
MOKBARBK83

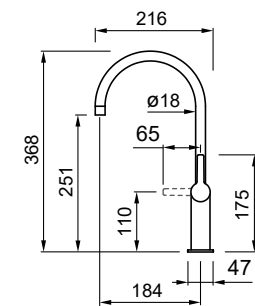

DIMENSIONE FORO / HOLE SIZE = \varnothing 35 mm
 BASE CANNA / SPOUT BASE = 47 x 47 mm
 ROTAZIONE CANNA / SPOUT ROTATION = 360°
 FLESSIBILE / FLEXI-HOSE = Inox 3/8" - 360 mm
 CARTUCCIA / CARTRIDGE = 25 mm



Smith



LEVA COLORATA
COLORED LEVER

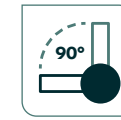

FUNZIONAMENTO
LEVA 0-90°
HANDLE ROT. 90°

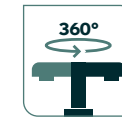

ROTAZIONE CANNA
SPOUT ROTATION



COLORE UNICO
FULL COLOUR

+ Miscelatore monocomando con canna girevole
Single-level tap with swivel spout

FINITURE / FINISHES

- CS Cromo spazzolato
MIKSMICS
- BK Black
MOKSMIBK

FINITURE LEVA / LEVER FINISHES

- Black K82 Sage
MOKSMIBK82
- Black K83 Clay
MOKSMIBK83

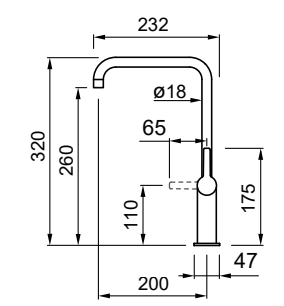

DIMENSIONE FORO / HOLE SIZE = \varnothing 35 mm
 BASE CANNA / SPOUT BASE = 47 x 47 mm
 ROTAZIONE CANNA / SPOUT ROTATION = 360°
 FLESSIBILE / FLEXI-HOSE = Inox 3/8" - 360 mm
 CARTUCCIA / CARTRIDGE = 25 mm



Eclipse



**DOCCETTA
SPRAYER**

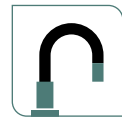

**TUBO SILICONE
NERO
BLACK SILICON
TUBE**



**CAMBIO GETTO
JET SWITCH-
OVER**

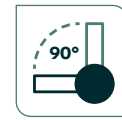

**FUNZIONAMENTO
LEVA 0-90°
HANDLE ROT. 90°**



**COLORE
UNICO
FULL COLOUR**

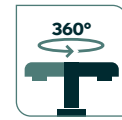

**ROTAZIONE CANNA
SPOUT ROTATION**



Miscelatore monocomando con canna alta girevole in silicone nero e doccetta doppio getto
Single-lever tap with tall silicone swivel spout and jet switch-over sprayer

FINITURE / FINISHES

-  CS Cromo spazzolato + BK Black
MIKECLCS
-  BK Black + BK Black
MOKECLBK
-  BZ Bronze + BK Black
MOKECLBZ

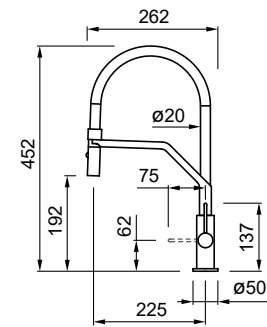

DIMENSIONE FORO / HOLE SIZE = \varnothing 35 mm

BASE CANNA / SPOUT BASE = \varnothing 50 mm

ROTAZIONE CANNA / SPOUT ROTATION = 360°

FLESSIBILE / FLEXI-HOSE = Inox 3/8" - 400 mm

CARTUCCIA / CARTRIDGE = 25 mm





Bahia



**DOCCETTA
SPRAYER**

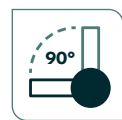

**FUNZIONAMENTO
LEVA 0-90°
HANDLE ROT. 90°**



**CAMBIO GETTO
JET SWITCH-OVER**

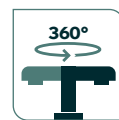

**ROTAZIONE CANNA
SPOUT ROTATION**



**COLORE UNICO
FULL COLOUR**

+ Miscelatore monocomando con canna alta girevole a molla continua e doccetta doppio getto
Single-lever tap with tall swivel spout with continuous spring and jet switch-over sprayer

FINITURE / FINISHES

● CS Cromo spazzolato
MIKBAHCS

● BK Black
MOKBAHBK

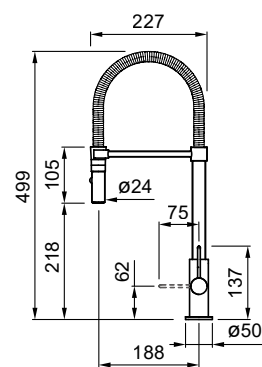

DIMENSIONE FORO / HOLE SIZE = \varnothing 35 mm
BASE CANNA / SPOUT BASE = \varnothing 50 mm
ROTAZIONE CANNA / SPOUT ROTATION = 360°
FLESSIBILE / FLEXI-HOSE = Inox 3/8" - 400 mm
CARTUCCIA / CARTRIDGE = 25 mm



Wave



**CON DOCCETTA
WITH SPRAYER**



**TUBO SILICONE
NERO
BLACK SILICON
TUBE**

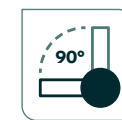

**FUNZIONAMENTO
LEVA 0-90°
HANDLE ROT. 90°**



**COLORE UNICO
FULL COLOUR**

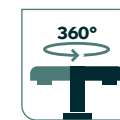

**ROTAZIONE CANNA
SPOUT ROTATION**

+ Miscelatore monocomando con canna alta girevole in silicone nero e doccetta
Single-lever tap with tall silicone swivel spout and sprayer

FINITURE / FINISHES

● CS Cromo spazzolato + BK Black
MIKWAVCS

● BK Black + BK Black
MOKWAVBK

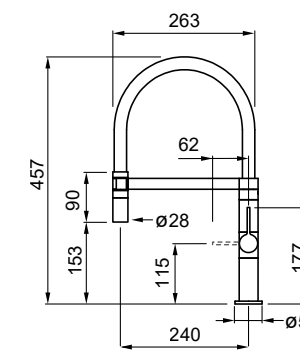

DIMENSIONE FORO / HOLE SIZE = \varnothing 35 mm
BASE CANNA / SPOUT BASE = \varnothing 50 mm
ROTAZIONE CANNA / SPOUT ROTATION = 360°
FLESSIBILE / FLEXI-HOSE = Inox 3/8" - 400 mm
CARTUCCIA / CARTRIDGE = 25 mm



Club



ROTAZIONE CANNA
SPOUT ROTATION

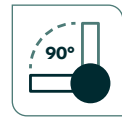

FUNZIONAMENTO
LEVA 0-90°
HANDLE ROT. 90°



COLORE UNICO
FULL COLOUR

+ Miscelatore monocomando con canna girevole
Single-lever tap with swivel spout

FINITURE / FINISHES

CS Cromo spazzolato
MIKCLUCS

BK Black
MOKCLUBK

GD Gold
MOKCLUGD

BZ Bronze
MOKCLUBZ

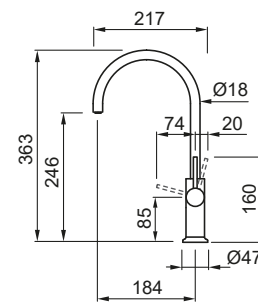

DIMENSIONE FORO / HOLE SIZE = \varnothing 35 mm
 BASE CANNA / SPOUT BASE = \varnothing 47 mm
 ROTAZIONE CANNA / SPOUT ROTATION = 360°
 FLESSIBILE / FLEXI-HOSE = Inox 3/8" - 390 mm
 CARTUCCIA / CARTRIDGE = 25 mm



Hype

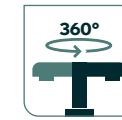

ROTAZIONE CANNA
SPOUT ROTATION

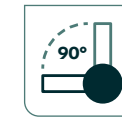

FUNZIONAMENTO
LEVA 0-90°
HANDLE ROT. 90°



COLORE UNICO
FULL COLOUR

+ Miscelatore monocomando con canna girevole
Single-lever tap with swivel spout

FINITURE / FINISHES

CS Cromo spazzolato
MIKHYPSC

BK Black
MOKHYPBK

GD Gold
MOKHYPGD

BZ Bronze
MOKHYPBZ

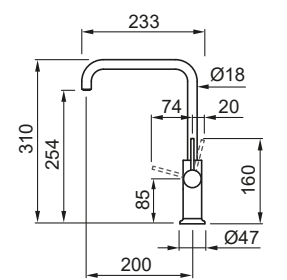

DIMENSIONE FORO / HOLE SIZE = \varnothing 35 mm
 BASE CANNA / SPOUT BASE = \varnothing 47 mm
 ROTAZIONE CANNA / SPOUT ROTATION = 360°
 FLESSIBILE / FLEXI-HOSE = Inox 3/8" - 390 mm
 CARTUCCIA / CARTRIDGE = 25 mm



Stream PLUS



DOCCETTA ESTRAIBILE
PULL-OUT SPRAYER

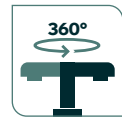

ROTAZIONE CANNA
SPOUT ROTATION

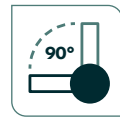

FUNZIONAMENTO LEVA 0-90°
HANDLE ROT. 90°



COLORE UNICO
FULL COLOUR

+ Miscelatore monocomando con canna girevole e doccetta estraibile
Single-lever tap with swivel spout and pull-out sprayer

FINITURE / FINISHES

● CS Cromo spazzolato
MIKSTPCS

● GD Gold
MOKSTPGD

● BK Black
MOKSTPBK

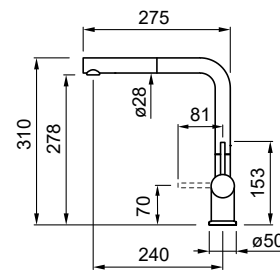

DIMENSIONE FORO / HOLE SIZE = \varnothing 35 mm

BASE / BASE = \varnothing 50 mm

ROTAZIONE CANNA / SPOUT ROTATION = 360°

FLESSIBILE / FLEXI-HOSE = Inox 3/8" - 350 mm

CARTUCCIA / CARTRIDGE = 35 mm



Trail

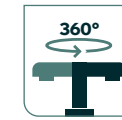

ROTAZIONE CANNA
SPOUT ROTATION

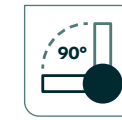

FUNZIONAMENTO LEVA 0-90°
HANDLE ROT. 90°



COLORE UNICO
FULL COLOUR

+ Miscelatore monocomando con canna girevole
Single-lever tap with swivel spout

FINITURE / FINISHES

● CS Cromo spazzolato
MIKTRACS

● GD Gold
MOKTRAGD

● BK Black
MOKTRABK

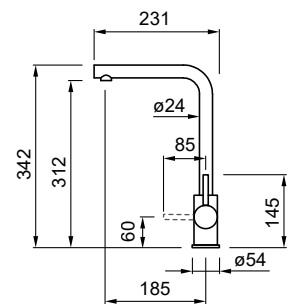

DIMENSIONE FORO / HOLE SIZE = \varnothing 35 mm

BASE / BASE = \varnothing 54 mm

ROTAZIONE CANNA / SPOUT ROTATION = 360°

FLESSIBILE / FLEXI-HOSE = Inox 3/8" - 400 mm

CARTUCCIA / CARTRIDGE = 35 mm



Show



**DOCCETTA
ESTRAIBILE
PULL-OUT
SPRAYER**



**COLORE UNICO
FULL COLOUR**



Doccetta estraibile monogetto,
solo acqua fredda
Switch-over sprayer, only cold water

FINITURE / FINISHES

- CS Cromo spazzolato
MIKSHOCS
- BK Black
MOKSHOBK

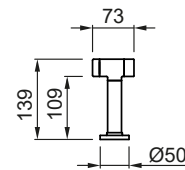

ABBINABILE A TUTTI MISCELATORI / MATCHABLE WITH ALL TAPS

DIMENSIONE FORO / HOLE SIZE = \varnothing 35 mm

BASE / BASE = \varnothing 50 mm

ROTAZIONE CANNA / SPOUT ROTATION = 360°

FLESSIBILE / FLEXI-HOSE = Inox 3/8" - 1500 mm



Sipario

Elettrodomestici

Built-in Appliances



Forme iconiche, materiali eccellenti e tecnologia intuitiva: Sipario è la linea di elettrodomestici di design per viziare i sensi ed esplorare nuove emozioni quotidiane. La bellezza eterna del nero raggiunge l'apice nell'eleganza opaca di tutti gli elementi. Ergonomia e modularità ispirano combinazioni scenografiche, in family line con i piani cottura matt black.

Iconic shapes, excellent materials and intuitive technology: Sipario is the range of designer appliances to cuddle the senses and explore new emotions every day. The eternal beauty of black reaches the height of matt elegance in all the elements. Ergonomics and modularity inspire scenographic combinations, in family line with matt black hobs.



Sipario Forno pirolitico 60

Pyrolytic oven 60



Estetica total black
Look total black



Autopulente
Self-cleaning



Display led bianchi
White led display



Manopole soft touch
Soft touch knobs



Guide telescopiche estraibili
Pull-out telescopic guides



Chiusura ammortizzata
Soft closing



Porta fredda
Cold door



Vetro porta removibile
Removable glass door



Forno pirolitico 60 cm estetica metallo nero opaco
Black matt metal pyrolytic oven 60 cm

FINITURE / FINISHES

BK Black
FPVS601BK

FUNZIONI FORNO = n° 9

CLASSE ENERGETICA = A+

CAPACITÀ = 65 L - cavità smaltata ultra black puntinata

COMANDI = digital timer + 2 manopole soft touch

PORTA = 4 vetri - finitura dark gray - soft closing

GUIDE = n° 1 coppia di guide lineari ad estrazione totale

LAMPADE ALOGENE = n° 2

ACCESSORI INCLUSI = n° 1 griglia, n° 1 leccarda smaltata

MAX ASSORBIMENTO = 3,5 kW

TENSIONE / FREQUENZA = 220-240 V / 50-60 Hz

OVEN FUNCTIONS = n° 9

ENERGY RATING = A+

CAPACITY = 65 L - enamelled dotted ultra black internal walls

CONTROLS = digital timer + 2 soft touch knobs

DOOR = 4 glasses - dark gray finish - soft closing

GUIDES = n° 1 pair of linear pull-out telescopic guides

HALOGEN LAMP = n° 2

INCLUDED ACCESSORIES = n° 1 grid, n° 1 enamelled tray

MAX ABSORPTION = 3,5 kW

TENSION / FREQUENCY = 220-240 V / 50-60 Hz

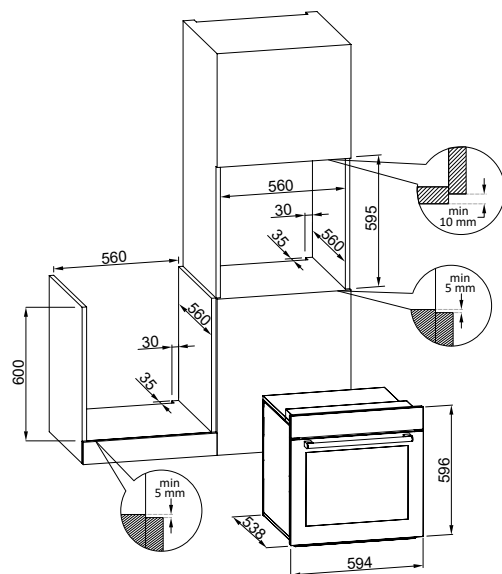





Sipario Forno termoventilato 60

Thermoventilated oven 60

- 

Estetica total black
Look total black
- 

12 Funzioni
12 Functions
- 

Display led bianchi
White led display
- 

Manopole soft touch
Soft touch knobs
- 

Guide telescopiche estraibili
Pull-out telescopic guides
- 

Chiusura ammortizzata
Soft closing
- 

Porta fredda
Cold door
- 

Vetro porta removibile
Removable glass door

+ Forno termoventilato 60 cm estetica metallo nero opaco
Black matt metal thermoventilated oven 60 cm

FINITURE / FINISHES

- BK Black**
FOVS601BK

FUNZIONI FORNO = n° 12

- CLASSE ENERGETICA = A**
- CAPACITÀ = 65 L** - cavità smaltata ultra black
- COMANDI = digital timer + 2 manopole soft touch**
- PORTA = 3 vetri** - completamente smontabile - finitura dark gray - soft closing
- GUIDE = n° 1 coppia di guide lineari ad estrazione totale**
- LAMPADA ALOGENA = n° 1**
- ACCESSORI INCLUSI = n° 1 griglia, n° 1 leccarda smaltata**
- MAX ASSORBIMENTO = 3,5 kW**
- TENSIONE / FREQUENZA = 220-240 V / 50-60 HZ**

OVEN FUNCTIONS = n° 12

- ENERGY RATING = A**
- CAPACITY = 65 L** - enamelled ultra black internal walls
- CONTROLS = digital timer + 2 soft touch knobs**
- DOOR = 3 glasses** - completely removable - dark gray finish - soft closing
- GUIDES = n° 1 pair of linear pull-out telescopic guides**
- HALOGEN LAMP = n° 1**
- INCLUDED ACCESSORIES = n° 1 grid, n° 1 enamelled tray**
- MAX ABSORPTION = 3,5 kW**
- TENSION / FREQUENCY = 220-240 V / 50-60 HZ**

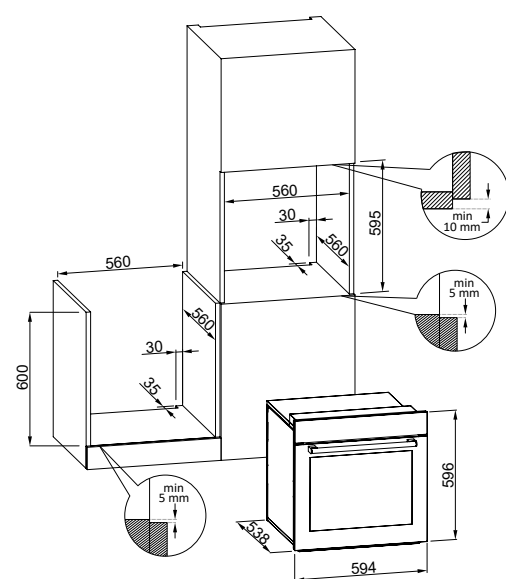



Sipario

Forno vapore 45 Steam oven 45



Estetica total black
Look total black



Vapore + Grill
Steam + Grill



Display led bianchi
White led display



Manopole soft touch
Soft touch knobs



Vetro porta rimovibile
Removable door glass



Porta fredda
Cold door



Forno vapore 45 cm estetica metallo nero opaco
Black matt metal steam oven 45 cm

FINITURE / FINISHES

BK Black
FVVS451BK

FUNZIONI FORNO = cottura vapore, grill, decalcificatore automatico

CLASSE ENERGETICA = A++

CAPACITÀ = 34 L - cavità Inox

COMANDI = digital timer + 2 manopole soft touch

PORTA = 3 vetri - finitura dark gray - soft closing

LAMPADA ALOGENA = n° 1

ACCESSORI INCLUSI = n° 1 griglia, n° 1 leccarda inox, vassoio inox microforato con coperchio, vassoio raccogli liquidi e supporto

MAX ASSORBIMENTO = 1,2 kW

TENSIONE / FREQUENZA = 220-240 V / 50-60 Hz

OVEN FUNCTIONS = steaming, grill, automatic water descaler

ENERGY RATING = A++

CAPACITY = 34 L - stainless steel made internal walls

CONTROLS = 2 soft touch knobs + display, digital timer

DOOR = 3 glasses (cool door) - dark gray finish

HALOGEN LAMP = n° 1

INCLUDED ACCESSORIES = n° 1 grill, n° 1 stainless steel drip pan, stainless steel tray with perforated cover, liquid collection tray

MAX ABSORPTION = 1,2 kW

TENSION / FREQUENCY = 220-240 V / 50-60 Hz

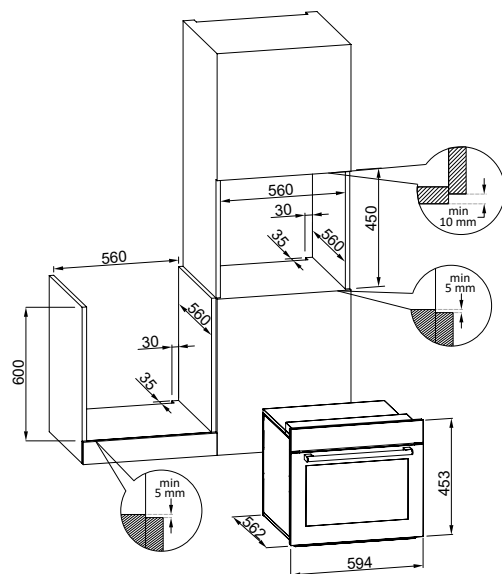



Sipario

Forno microonde 45 Microwave oven 45



Estetica total black
Look total black



Microonde + Grill
Microwave + Grill



Display led bianchi
White led display



Manopole soft touch
Soft touch knobs



Scongellamento
Defrosting



Forno microonde 45 cm estetica metallo nero opaco
Black matt metal microwave oven 45 cm

FINITURE / FINISHES

BK Black
FMVS451BK

FUNZIONI FORNO = microonde (6 livelli di potenza),
microonde & grill, scongelamento

CAPACITÀ = 34 L - Cavità Inox

COMANDI = 2 manopole soft touch + display, timer digitale

LAMPADA ALOGENA = n° 1

ACCESSORI INCLUSI = n° 1 griglia, n° 1 griglia circolare,
piatto girevole in vetro

MAX ASSORBIMENTO = 3,2 kW

TENSIONE / FREQUENZA = 220-240 V / 50-60 Hz

OVEN FUNCTIONS = microwave (6 power levels),
microwave & grill, defrosting

CAPACITY = 34 L - stainless steel made internal walls

CONTROLS = digital timer + 2 soft touch knobs, digital timer

HALOGEN LAMP = n° 1

INCLUDED ACCESSORIES = n° 1 grid, n° 1 circular grid, glass
turntable

MAX ABSORPTION = 3,2 kW

TENSION / FREQUENCY = 220-240 V / 50-60 Hz

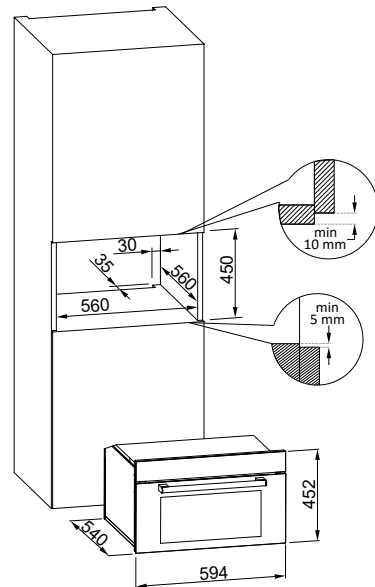



Sipario

Cantinetta 45 Wine Cellar 45



Estetica total black
Look total black



Capacità
Capacity



Display digitale touch
Touch digital display



Temperatura regolabile
Temperature adjustable



Chiusura ammortizzata
Soft closing



Ripiani telescopici
Sliding shelves



Illuminazione interna
Interior lighting



Cantinetta 45 cm estetica metallo nero opaco
Black matt metal wine cellar 45 cm

FINITURE / FINISHES

BK Black
CAVS451BK

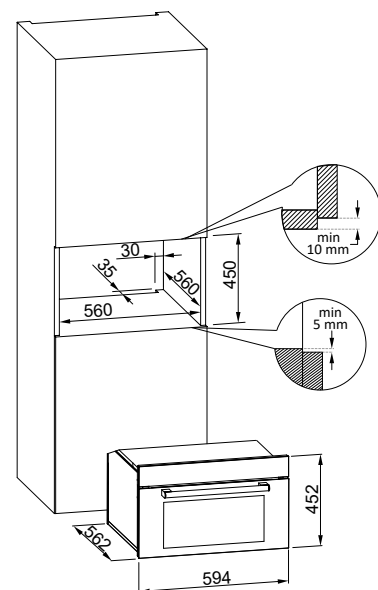

TEMPERATURA = regolabile tra +5°C e 20°C

CLASSE ENERGETICA = G

CAPACITÀ = 22 bottiglie (diametro ø 76 mm)

COMANDI = display digitale touch

PORTA VETRO = finitura dark grey non permette vedere interno se luce della cavità è spenta, apertura a ribalta - soft closing

ILLUMINAZIONE = n° 1 led

ACCESSORI INCLUSI = n° 3 ripiani scorrevoli in legno di faggio

GUIDE = coppia di guide telescopiche

MAX ASSORBIMENTO = 80 W

TENSIONE / FREQUENZA = 220-240 V / 50-60 Hz

TEMPERATURE = adjustable tra +5°C e 20°C

ENERGY RATING = G

CAPACITY = 22 bottles (diameter ø 76 mm)

CONTROLS = digital touchscreen

GLASS DOOR = dark grey finish it does not allow to see inside if light is off, flap opening - soft closing

LIGHTING = n°1 led

INCLUDED ACCESSORIES = n° 3 sliding beechwood shelves

GUIDES = telescopic guides

MAX ABSORPTION = 80 W

TENSION / FREQUENCY = 220-240 V / 50-60 Hz





Sipario

Cassetto riscaldante / Porta oggetti 15 Warming / Storage drawer 15



Estetica total black
Look total black



Apertura push pull
Push/pull open



Guide telescopiche estraibili
Pull-out telescopic guides



Piano removibile
Removable base



Scongelamento
Defrosting



Mantenimento in caldo, lievitazione, cottura lenta
Plate warmer, leavening, slow cooking

- + Cassetto riscaldante 15 cm estetica metallo nero opaco con piano interno in vetro
Black matt metal warming drawer 15 cm with inner glass shelf

FINITURE / FINISHES

● BK Black
CRVS151BK

FUNZIONI = mantenimento in caldo, scongelamento, lievitazione, cottura bassa temperatura (max 70°C), preriscaldamento stoviglie e tazzine caffè

APERTURA = push pull estrazione totale

COMANDI = on / off

TENSIONE / FREQUENZA = 220-240 V / 50-60 Hz

FUNCTIONS = ventilated, maintaining hot food, defrosting, leavening, low temperature cooking (max 70°C), preheating dishes and coffee cups

OPENING = push pull, totally extractable

CONTROLS = on / off light

TENSION / FREQUENCY = 220-240 V / 50-60 Hz

- + Cassetto porta oggetti 15 cm estetica metallo nero opaco con piano interno in vetro
Black matt metal storage drawer 15 cm with inner glass shelf

FINITURE / FINISHES

● BK Black
CSVS151BK

APERTURA = push pull, estrazione totale

OPENING = push pull, totally extractable

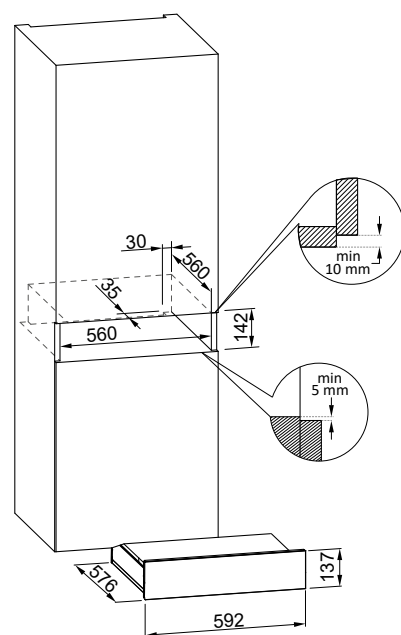

Piani cottura Hobs



Sipario

La ricerca materica della collezione Sipario spinge lo stile oltre i confini conosciuti.

La vetroceramica nobilita il design minimalista dei piani cottura a induzione con l'esclusiva superficie ultra opaca; delicato il contrasto con l'area comandi touch-sliding illuminata da led bianchi. La profondità del nero dà carattere e innalza l'impatto estetico dei piani cottura a gas.

The research into materials of Sipario collection pushes style beyond familiar boundaries.

Ultra-matt glass ceramic elevates the minimalist design of induction hobs, creating an harmonious contrast with the white led touch-sliding control area. The depth of black adds character and underscores the aesthetic impact of the gas hobs.



Sipario

Piano aspirante 80 Extractor hob 80



Estetica total black
Look total black



Display led bianchi
White led display



Comandi slider
Sliding touch control



Funzione bridge
Bridge zone



Sospensione e riavvio cottura
Stop/Go



Flap di aspirazione 360°
360° Adjustable extraction flap



Filtri rigenerabili
Regenerable filters



Vassoio raccolta liquidi 5 L
Removable liquid collection tray 5 L



Piano induzione aspirante 80 cm in vetroceramica nero opaco con 4 zone di cottura, funzione Bridge
Black matt glass ceramic induction hob 80 cm with hood and 4 cooking zones with Bridge function

FINITURE / FINISHES

● Metropolitan Black
PAIS801BK

INSTALLAZIONE = filotop, flat

COMANDI = led bianchi e comandi slider per singola zona 4 cottura + 1 cappa aspirante con 9 livelli di potenza + booster

FUNZIONI = riscaldamento automatico rapido, booster cottura, timer cottura, timer autonomo, pausa e riavvio, rilevamento presenza pentola

SICUREZZA = blocco tasti, sicurezza bambini, indicazione calore residuo

ZONE COTTURA = 4 zone 210x190 mm potenza 2,1 kW - Booster 3 kW Bridge 3,7 kW

ASSORBIMENTO = 8 livelli di limitazione da 1 a 7,4 kW

ALIMENTAZIONE = monofase 220-240 V 50-60 Hz, bifase 380-415 V 50-60 Hz

COMANDI CAPPA = led bianchi e comando slider

FUNZIONI CAPPA = aspirante con espulsione esterna e filtrante con filtri carboni attivi rigenerabili in dotazione, funzionamento automatico in base al livello di potenza, timer cappa con autospegnimento, indicazione stato saturazione filtri antigraasso e filtri carboni attivi, flap per indirizzare flusso di aspirazione (un lato metallo e l'altro vetroceramica)

ACCESSORI INCLUSI = n°2 curve 90° e un tratto lunghezza 1 metro lineare sezione rettangolare (compatibili naber/i-tube)

MOUNTING = flushmount, flat

CONTROLS = white leds and single zone slider 4 cooking + 1 extractor hood with 9 power levels + booster

FUNCTIONS = automatic rapid heating, cooking booster, cooking timer, autonomous timer, pause and restart, pot presence detection

SAFETY = key lock, child safety, residual heat indication

COOKING ZONES = 4 zones 210x190mm, power 2,1 kW, Booster 3 kW, Bridge 3,7 kW

ABSORPTION = 8 levels of limitations from 1 to 7.4 kW

POWER SUPPLY = single phase 220-240 V 50-60 Hz, two phases 380-415 V 50-60 Hz

HOOD CONTROLS = white leds and slider command

FUNCTIONS = aspirant with external expulsion and filtered with included regenerable activated charcoal filters, automatic operation according to power level, hood timer with auto-off, grease filter saturation status indication, indication for charcoal filter saturation status, flap to direct aspirant flow (one side in metal and other in glass ceramic)

INCLUDED ACCESSORIES = 2 x 90° bent and 1 linear meter rectangular section pipe (naber / i-tube adaptable)

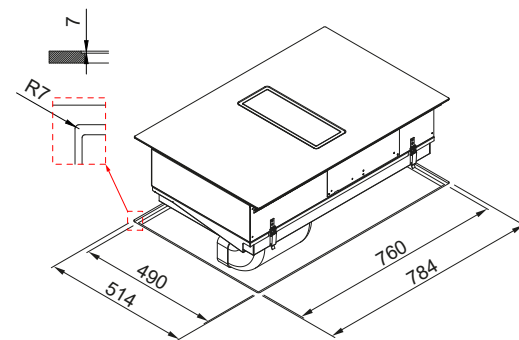
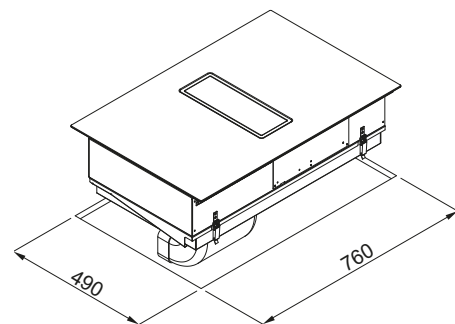



Sipario

Piano induzione 80 Induction hob 80



Estetica total black
Look total black



Display led bianchi
White led display



Comandi slider
Sliding touch control



Funzione bridge
Bridge zone



Sospensione e riavvio cottura
Stop/Go



Cottura chef
Chef cook



Mantenimento in caldo
Keep warming



Piano induzione 80 cm in vetroceramica nero opaco con 4 zone di cottura, funzione Bridge lato sx
Black matt glass ceramic induction hob 80 cm and 4 cooking zones with Bridge function left side

FINITURE / FINISHES

● **Metropolitan Black**
PIVS801BK

INSTALLAZIONE = filotop, flat

ZONE COTTURA = 4 zone 210x190 mm potenza 2,1 kW
- Booster 3 kW Bridge 3,7 kW, 1 zona Ø 250 mm 2,3 kW
- Booster 3 kW, 1 zona Ø 160 mm 1,4 kW - Booster 2,1 kW

COMANDI = Led bianchi e comandi slider per singola zona con 9 livelli di potenza + booster

FUNZIONI = riscaldamento automatico rapido, booster cottura, timer cottura con allarme acustico, timer autonomo, pausa e riavvio, rilevamento presenza pentola
CHEF: preimpostazione 3 zone su livelli 6-2-9
KEEP WARM: mantenimento in caldo

SICUREZZA = blocco tasti, sicurezza bambini, indicazione calore residuo

ASSORBIMENTO = 8 livelli di limitazione da 1,6 kW a 7,4 kW (1,6-2,1-2,8-3,7-4,3-5-6-7,4 kW)

ALIMENTAZIONE = monofase 220-240 V 50-60 Hz, bifase 380-415 V 50-60 Hz

POTENZA MAX = 7,4 kW

MOUNTING = flushmount, flat

COOKING ZONES = 4 zones 210x190mm, power 2,1 kW
- Booster 3 kW, Bridge 3,7 kW, 1 zone Ø 250mm 2,3 kW
- Booster 3 kW, 1 zone Ø 160 1,4 kW - Booster 2,1 kW

CONTROLS = white leads and single zone slider for each cooking zone with 9 power leveles + booster

FUNCTIONS = automatic rapid heating, cooking booster, cooking timer with acoustic alarm, autonomous timer, pause and restart, pot presence detection
CHEF function on 3 zones - 6-2-9 levels
KEEP WARM function

SAFETY = key lock, child safety, residual heat indication

ABSORPTION = 8 levels of limitations from 1,6 to 7,4 kW (1,6-2,1-2,8-3,7-4,3-5-6-7,4 kW)

POWER SUPPLY = single phase 220-240 V 50-60 Hz, two phases 380-415 V 50-60 Hz

MAX POWER = 7,4 kW

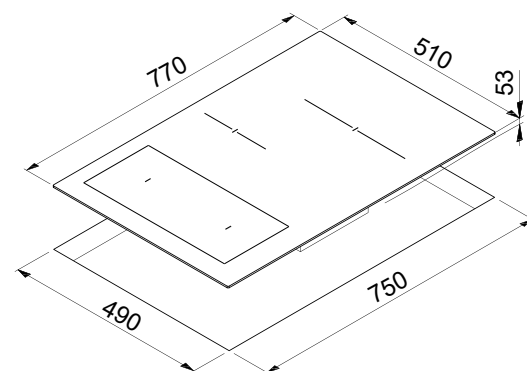



Sipario

Piano induzione 60 Induction hob 60



Estetica total black
Look total black



Display led bianchi
White led display



Comandi slider
Sliding touch control



Funzione bridge
Bridge zone



Sospensione e riavvio cottura
Stop/Go



Cottura chef
Chef cook



Mantenimento in caldo
Keep warming



Piano induzione 60 cm in vetroceramica nero opaco con 4 zone di cottura, funzione Bridge lato sx
Black matt glass ceramic induction hob 60 cm and 4 cooking zones with Bridge function left side

FINITURE / FINISHES

● **Metropolitan Black**
PIVS601BK

INSTALLAZIONE = filotop, flat

ZONE COTTURA = 4 zone 210x190 mm potenza 2,1 kW
- Booster 3 kW Bridge 3,7 kW, 1 zona Ø 200 mm 2,3 kW
- Booster 3 kW, 1 zona Ø 160 mm 1,4 kW - Booster 2,1 kW

COMANDI = led bianchi e comandi slider per singola zona con 9 livelli di potenza + booster

FUNZIONI = Riscaldamento automatico rapido, timer cottura con allarme acustico, timer autonomo, pausa e riavvio, Rilevamento presenza pentola
CHEF: preimpostazione 3 zone su livelli 6-2-9
KEEP WARM: mantenimento in caldo

SICUREZZA = blocco tasti, sicurezza bambini, Indicazione calore residuo

ASSORBIMENTO = 8 Livelli di limitazione da 1,6 kW a 7,4 kW (1,6-2,1-2,8-3,7-4,3-5-6-7,4 kW)

ALIMENTAZIONE = monofase 220-240 V 50-60 Hz, bifase 380-415 V 50-60 Hz

POTENZA MAX = 7,4 kW

MOUNTING = flushmount, flat

COOKING ZONES = 4 zones 210x190mm, power 2,1 kW
- Booster 3 kW, Bridge 3,7 kW, 1 zone Ø 200mm 2,3 kW
- Booster 3 kW, 1 zone Ø 160 1,4 kW - Booster 2,1 kW

CONTROLS = white leads and single zone slider for each cooking zone with 9 power leveles + booster

FUNCTIONS = automatic rapid heating, cooking booster, cooking timer with acoustic alarm, autonomous timer, pause and restart, pot presence detection
CHEF function on 3 zones - 6-2-9 levels
KEEP WARM function

SAFETY = key lock, child safety, residual heat indication

ABSORPTION = 8 levels of limitations from 1 to 7.4 kW (1.6-2.1-2.8-3.7-4.3-5-6-7.4 kW)

POWER SUPPLY = single phase 220-240 V 50-60 Hz, two phases 380-415 V 50-60 Hz

MAX POWER = 7,4 kW

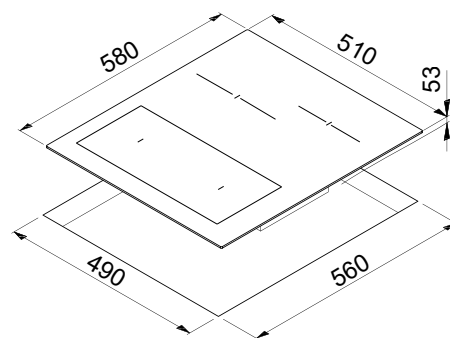



Sipario

Piano induzione 30 Induction hob 30



Estetica total black
Look total black



Display led bianchi
White led display



Comandi slider
Sliding touch control



Funzione bridge
Bridge zone



Sospensione e riavvio cottura
Stop/Go



Mantenimento in caldo
Keep warming



Piano induzione 30 cm in vetroceramica nero opaco con 2 zone di cottura, funzione Bridge
Black matt glass ceramic induction hob 30 cm and 2 cooking zones with Bridge function

FINITURE / FINISHES

● **Metropolitan Black**
PIVS301BK

INSTALLAZIONE = filotop, flat

ZONE COTTURA = 2 zone 210x190 mm potenza 2,1 kW
- Booster 3 kW Bridge 3,7 kW

COMANDI = led bianchi e comandi slider per singola zona con 9 livelli di potenza + booster

FUNZIONI = riscaldamento automatico rapido, timer cottura con allarme acustico, timer autonomo, pausa e riavvio, rilevamento presenza pentola
KEEP WARM: mantenimento in caldo

SICUREZZA = blocco tasti, sicurezza bambini, indicazione calore residuo

ASSORBIMENTO = 4 livelli di limitazione da 1,6 kW a 3,7 kW (1,6-2,1-2,8-3,7 kW)

ALIMENTAZIONE = monofase 220-240 V 50-60 Hz, bifase 380-415 V 50-60 Hz

POTENZA MAX = 7,4 kW

MOUNTING = flushmount, flat

COOKING ZONES = 2 zones 210x190mm, power 2,1 kW
- Booster 3 kW, Bridge 3,7 kW

CONTROLS = white leds and single zone slider 2 cooking with 9 power levels + booster

FUNCTIONS = automatic rapid heating, cooking timer with acoustic alarm, autonomous timer, pause and restart, pot presence detection
KEEP WARM function

SAFETY = key lock, child safety, residual heat indication

ABSORPTION = 4 levels of limitations from 1,6kW to 3,7 kW (1.6-2.1-2.8-3.7 kW)

POWER SUPPLY = single phase 220-240 V 50-60 Hz, two phases 380-415 V 50-60 Hz

MAX POWER = 7,4 kW

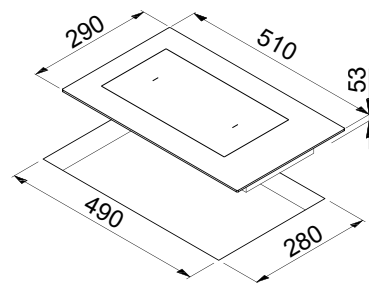



Plano Plus

Piano gas 75 Gas hob 75



Bruciatori piatti
Flat burners



Corona Wok
Wok burner



9 livelli di
potenza
Step flame
control



Griglie in ghisa
Cast iron grills



Accensione
integrata
Integrated
ignition system



Piano cottura gas 75 cm smaltato nero opaco con griglie in ghisa e wok centrale
Enameled black matt gas hob 75 cm with cast iron grids and wok burner central position

FINITURE / FINISHES

● Matt Black
PGPP751BKCS



PIANO = piano cottura smaltato con bruciatori piatti

COMANDI = manopole nere soft touch

FUNZIONI = step flame control su 9 livelli di potenza, accensione elettrica integrata sotto manopola, griglie e copri spartifiamma in ghisa, 5 bruciatori gas, 1 ausiliario 1 kW, 2 semirapido 1,75 kW, 1 rapido 3 kW centrale

SICUREZZA = termovalvola di sicurezza

HOB = flat burner full black

CONTROLS = black knobs soft touch

FUNCTIONS = step flame control on 9 power levels, integrated electric ignition under knob, cast iron grids and flame covers, 5 gas burners, 1 auxiliary 1 kW, 2 semi-rapid 1.75 kW, 1 rapid 3 kW central

SAFETY = safety thermovalve

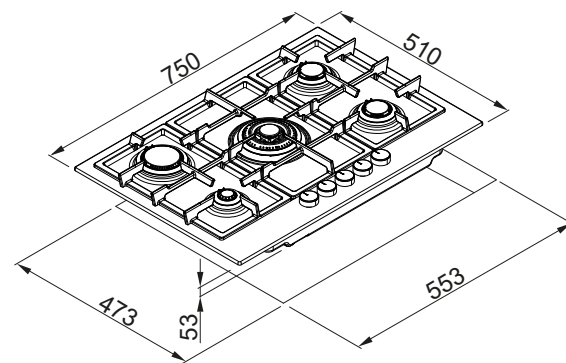



Plano Plus

Piano gas 75 laterale
Gas hob 75 side



Bruciatori piatti
Flat burners



Corona Wok
Wok burner



9 livelli di
potenza
Step flame
control



Griglie in ghisa
Cast iron grills



Accensione
integrata
Integrated
ignition system



Piano cottura gas 75 cm smaltato nero opaco con griglie in ghisa e wok laterale sx
Enameled black matt gas hob 75 cm with cast iron grids and wok burner left side

FINITURE / FINISHES

● Matt Black
PGPP751BKSB



PIANO = piano cottura smaltato con bruciatori piatti

COMANDI = manopole nere soft touch

FUNZIONI = step flame control su 9 livelli di potenza, accensione elettrica integrata sotto manopola, griglie e copri spartifiamma in ghisa, 5 bruciatori gas, 1 ausiliario 1 kW, 2 semirapido 1,75 kW, 1 rapido 3 kW centrale

SICUREZZA = termovalvola di sicurezza

HOB = flat burner full black

CONTROLS = black knobs soft touch

FUNCTIONS = step flame control on 9 power levels, integrated electric ignition under knob, cast iron grids and flame covers, 5 gas burners, 1 auxiliary 1 kW, 2 semi-rapid 1.75 kW, 1 rapid 3 kW central

SAFETY = safety thermostatic valve

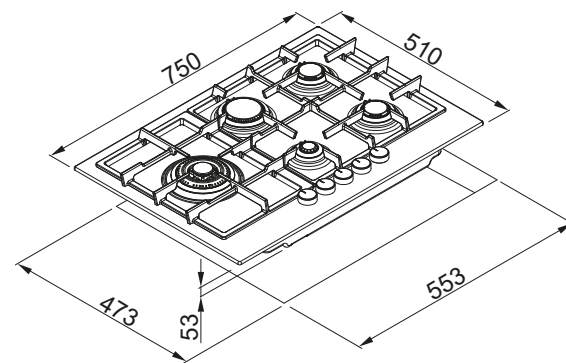



elleci beauty

Cura e manutenzione Care and maintenance

Un set di prodotti con specifiche caratteristiche, realizzati per facilitare la pulizia e mantenere nel tempo la bellezza dei prodotti Elleci.

A series of products with specific features, designed to facilitate cleaning and maintain the beauty of Elleci products over time.

Mantenere nel tempo l'estetica e la funzionalità del prodotto è estremamente semplice. È sufficiente pulire ed asciugare quotidianamente utilizzando detergenti neutri o specifici della linea Elleci Beauty senza lasciare che depositi e residui agiscano a lungo sulle superfici.

Maintaining the aesthetics and functionality of the bowl over time is extremely simple. Just clean the bowl daily with water, dish detergent or Elleci Beauty specific product and a soft cloth, without letting deposits and residues act for a long time on the surfaces.



Una linea studiata con caratteristiche specifiche per facilitare le operazioni quotidiane di pulizia e cura del materiale in composito e mantenere nel tempo la bellezza dei prodotti Elleci.

A product line designed with specific features to facilitate daily cleaning and care of composite material and maintain the beauty of Elleci products over time.



0,2LT/KG
DLL01602

DEEP CLEANER Extra Action

Detergente in crema con azione smacchiante, rimuove le macchie più ostiche su tutti i lavelli e lavabi in composito Elleci di colore chiaro.

A cream detergent with stain-removing action, it removes stubborn stains on all light-colored Elleci composite sinks and basins.



0,2LT/KG
DLC01603

DEEP CLEANER Sgrassante

Detergente spray sgrassante, rimuove tracce di sporco, germi e batteri rispettando le superfici. È indicato per la pulizia periodica dei lavelli e lavabi in composito Elleci.

A degreasing spray cleaner, it removes traces of dirt, germs and bacteria while respecting surfaces. It is suitable for periodic cleaning of Elleci composite sinks and basins.



0,2LT/KG
DLA01603

DAILY CLEANER Anticalcare

Detergente spray anticalcare, scioglie le incrostazioni rispettando le superfici. È indicato per una pulizia periodica dei lavelli e lavabi in composito Elleci.

An anti-scale spray cleaner, dissolves scale while respecting surfaces. It is suitable for periodic cleaning of Elleci sinks and composite sinks.



0,1LT/KG
DLP01601

Beauty Protector

Detergente spray protettivo, salvaguarda da sporco, residui calcarei e mantiene la bellezza del prodotto nel tempo ravvivando la colorazione e aumentandone l'idrorepellenza.

Protective spray cleaner, safeguards against dirt, lime residue and maintains the beauty of the product over time by reviving the coloring and increasing its water repellency.



0,25LT/KG
DLA01602

DAILY CLEANER Clean Power

Detergente spray di pulizia specifico per superfici colorate e smaltate. È indicato per una pulizia quotidiana dei miscelatori e degli elettrodomestici colorati Elleci.

Specific spray cleaner for colored and enameled surfaces. It is suitable for daily cleaning of Elleci colored taps and appliances.



DKP01000

FAST CLEAN Kit Spugne / Sponges

Kit composto da 3 spugne antigraffio dotate di doppio stato utile a rimuovere lo sporco, anche il più intenso. La parte bianca agisce senza graffiare le superfici delicate, mentre la parte blu morbida ha un potere assorbente.

Kit consisting of 3 scratch-resistant sponges equipped with dual states useful for removing dirt, even the most intense dirt. The white part acts without scratching delicate surfaces, while the soft blue part has absorbent power.

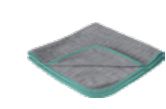

DKP01001

FAST CLEAN Panni in microfibra

Kit composto da 2 panni in microfibra con speciale motivo a scacchiera ad alta assorbenza per lasciare asciutto il lavello e togliere ogni residuo lasciando inalterata la superficie.

Kit consisting of 2 microfiber cloths with special high absorbency checkerboard pattern to leave the sink dry and remove any residue, leaving the surface unaffected.



ESP0166

Espositore da banco Prodotti per la pulizia

Un comodo box impilabile in cartone disponibile su richiesta. A convenient stackable cardboard box available upon request.

Rimuovere eventuali macchie utilizzando una spugna morbida e un detergente neutro per i piatti o un prodotto specifico della linea Elleci Beauty.



Remove any stains using a soft cloth or sponge with normal dish detergent or a specific Elleci Beauty product.

Risciacquare abbondantemente le superfici utilizzando acqua tiepida.



Rinse the surfaces thoroughly with warm water.

Asciugare con cura la superficie con un panno morbido o in microfibra per impedire la formazione di depositi di calcare.



Dry the wet areas thoroughly with a microfibre cloth to prevent the formation of limescale deposits.

Per prevenire la formazione delle macchie di calcare sulla superficie, si raccomanda di eseguire una pulizia più approfondita una o due volte alla settimana utilizzando un detergente anticalcare disincrostante come lo spray anticalcare Daily Clean della linea Elleci Beauty.













To prevent the formation of limestone stains on the bowl, it is also recommended to decalcify the bowl once or twice a week, using a descaling detergent or a specific Elleci Beauty product as Daily Clean anti-limescale spray.













Ulteriori avvertenze e consigli
Additional warnings and advices



Spare parts

Parti / Parts	Codice / Code
 <p>SET PILETTA FLOW PRO CON TROPPOPIENO SLIM INOX Scarico piletta una via da 3-1/2" con tappo cestello Flow Pro Inox e tubo corrugato con troppopieno slim "Elleci" Inox. FLOW-PRO WASTE SET WITH SLIM OVERFLOW INOX Black one-way 3.5" waste with Stainless Steel Flow-Pro basket strainer plug and corrugated pipe, with slim stainless steel "Elleci" overflow.</p>	KITWPT-F-1VSSL-IN
 <p>SET PILETTA FLOW PRO CON TROPPOPIENO SLIM NERO Scarico piletta una via da 3-1/2" con tappo cestello Flow Pro Nero e tubo corrugato con troppopieno slim "Elleci" Nero. FLOW-PRO WASTE SET WITH SLIM OVERFLOW BLACK Black one-way 3.5" waste with Black Flow-Pro basket strainer plug and corrugated pipe, with slim Black "Elleci" overflow.</p>	KITWPT-F-1VSSL-BK
 <p>SET PILETTA FLOW PRO CON TROPPOPIENO SLIM GOLD Scarico piletta una via da 3,1/2" con tappo cestello Flow Pro Gold e tubo corrugato con troppopieno slim "Elleci" Gold. FLOW-PRO WASTE SET WITH SLIM OVERFLOW GOLD Black one-way 3.5" waste with Gold Flow-Pro basket strainer plug and corrugated pipe, with slim Gold "Elleci" overflow.</p>	KITWPT-F-1VSSL-GD
 <p>SET PILETTA FLOW PRO CON TROPPOPIENO SLIM BRONZE Scarico piletta una via da 3,1/2" con tappo cestello Flow Pro Bronze e tubo corrugato con troppopieno slim "Elleci" Bronze. FLOW-PRO WASTE SET WITH SLIM OVERFLOW BRONZE Black one-way 3.5" waste with Bronze Flow-Pro basket strainer plug and corrugated pipe, with slim Bronze "Elleci" overflow.</p>	KITWPT-F-1VSSL-GD
 <p>TAPPO SCARICO FLOW PRO INOX FLOW-PRO BASKET STRAINER PLUG INOX</p>	TAPF01IN
 <p>TAPPO SCARICO FLOW PRO NERO FLOW-PRO BASKET STRAINER PLUG BLACK</p>	TAPF01BK
 <p>TAPPO SCARICO FLOW PRO GOLD FLOW-PRO BASKET STRAINER PLUG GOLD</p>	TAPF01IN
 <p>TAPPO SCARICO FLOW PRO BRONZE FLOW-PRO BASKET STRAINER PLUG BRONZE</p>	TAPF01BZ
 <p>KIT SCARICO CANALE Kit scarico con griglia nera per canale con tubo corrugato e adattatore sifone incluso. DRAIN KIT Drain kit with black channel grating with corrugated pipe and siphon adapter included.</p>	KTCMNA-BK
 <p>ACCESSORIO COVER MIXOLOGY FINITURA INOX Accessorio cover piletta in tecnopolimero finitura Inox MIXOLOGY COVER ACCESSORY STAINLESS STEEL FINISH Cover accessory technopolymer drain Stainless Steel finish</p>	ACPP1000IN
 <p>ACCESSORIO COVER MIXOLOGY FINITURA NERO Accessorio cover piletta in tecnopolimero finitura nero MIXOLOGY COVER ACCESSORY BLACK FINISH Cover accessory technopolymer drain Black finish</p>	ACPP1000BK

Per l'acquisto di ricambi/componenti dei prodotti appartenenti alla gamma Élite Kitchen rivolgersi presso i rivenditori ufficiali o direttamente sul sito "elleci.shop"*
(*valido solo per il territorio italiano)

Parti / Parts	Codice / Code
 <p>SET SIFONERIA UNA VIA Sifone ispezionabile salvaspazio a una via per lavelli una vasca. ONE-WAY SIPHON SET One-way space-saving inspectable siphon for one-bowl sinks.</p>	COMPSIF1V
 <p>SET SIFONERIA DUE VIE Sifone ispezionabile salvaspazio a due vie per lavelli due vasche. TWO-WAY SIPHON SET Two-way space-saving inspectable siphon for one-bowl sinks.</p>	COMPSIF2V
 <p>SET GANCI SOPRATOP N°6 ganci fissaggio ad inclinazione 23° con viti premontate e spessori in plastica, per fissaggio lavello composito. INSET HOOK SET N°6 23° mounting hooks with pre-mounted screws and plastic spacers, for fitting of composite sinks.</p>	BOXGAN06
 <p>SET GANCI SOPRATOP N°6 ganci fissaggio ad inclinazione 90° con viti premontate e spessori in plastica, per fissaggio lavello composito. INSET HOOK SET N°6 90° mounting hooks with pre-mounted screws and plastic spacers, for fitting of composite sinks.</p>	BOXGAN06S
 <p>SET GANCI SOPRATOP PER DIALOGO O CANALE Kit 4 ganci completi per lavello Dialogo o Canale attrezzato. SOPRATOP HOOKS SET FOR DIALOGO OR EQUIPPED TRACK Kit 4 complete sink hooks for Dialogo or Equipped track.</p>	BOXGAN07
 <p>SET GANCI SOTTOTOP N°6 ganci fissaggio con viti per lavello composito ad installazione sottotop. UNDERMOUNT HOOK SET N°6 mounting hooks with screws for undermount-fitted composite sinks.</p>	AKS01301
 <p>ESPOSITORE DA BANCO PRODOTTI PER LA PULIZIA Box cartone set prodotti per la pulizia. COUNTERTOP DISPLAY STAND CLEANING PRODUCTS Box carton set cleaning products.</p>	ESP0166
 <p>FRESA A TAZZA Fresa a tazza diamantata, diametro 35mm per effettuare foro miscelatore su lavello composito. DIAMOND DRILL Diamond drill 35 mm specific for composite sink</p>	FRES17
 <p>FILTRO SEDIMENTI - ULTRA Ricambio pre-filtrazione Pure Case ULTRA (meccanica 5 micron) SEDIMENTS FILTER ULTRA Sediments filter Pure Case ULTRA spare part (5 micron)</p>	RFPSEDU18
 <p>FILTRO MULTISTADIO - ULTRA Ricambio filtrazione Pure Case ULTRA multistadio (meccanica 0,15 micron, carboni attivi e sali argento) MULTISTAGE FILTER - ULTRA Multistage filter Pure Case ULTRA spare part (0,15 micron)</p>	RFPMULU18
 <p>FILTRO MULTISTADIO - MICRO Ricambio filtrazione Pure Case MICRO multistadio (meccanica 0,5 micron, carboni attivi e sali argento) MULTISTAGE FILTER - MICRO Multistage filter Pure Case MICRO spare part (0,5 micron)</p>	RFPMULM

For the purchase of spare parts/components of products belonging to the Élite Kitchen line, please contact official dealers or directly on the website "elleci.shop"*
(*valid only for Italian territory)

elleci è sempre più vicina a te is closer to you

Elleci ha cura dei propri clienti e lo dimostra utilizzando i materiali più innovativi e le tecnologie più all'avanguardia per offrire il massimo della qualità.

Qualità certificata da precise norme di produzione, conformi a ISO 9001:2015, ISO 14001:2015 e ISO 45001:2018.

Elleci ti assicura una garanzia della durata variabile, a seconda della categoria del prodotto che hai scelto.

Tali durate sono indicate nei rispettivi manuali di utilizzo/installazione.

Elleci cares about its customers and demonstrates this by using the most innovative materials and state-of-the-art technologies to offer the highest quality.

Quality certified by precise production standards, complying with ISO 9001:2015, ISO 14001:2015 and ISO 45001:2018.

Elleci assures you of a guarantee of varying durations, depending on the category of the product you have chosen.

These durations are indicated in the respective use/installation manuals.

Prodotto / Product	Garanzia / Warranty
Lavelli composito garanzia 2 anni* Keratek Composite sinks 2-year warranty* Keratek	20 Anni / Years
Lavelli composito garanzia 2 anni* Granitek Composite sinks 2-year warranty* Granitek	10 Anni / Years
Lavelli Inox / Miscelatori / Elettrodomestici / Accessori Stainless Steel Sinks / Taps / Appliances / Accessories	2 Anni / Years
Dissipatori / Foodwaste disposers	2 Anni / Years

*
Elleci offre ai suoi clienti la possibilità, previa registrazione prodotto, di usufruire anche della garanzia convenzionale (oltre quella legale) di 10 anni per i lavelli in Granitek e 20 anni per i lavelli in Keratek.

Elleci offers its customers the opportunity, upon product registration, to also take advantage of the conventional warranty (in addition to the legal one) of 10 years for Granitek sinks and 20 years for Keratek sinks.

Modalità di assistenza tecnica

LAVELLI | MISCELATORI | ACCESSORI | DISSIPATORI

In caso di assistenza tecnica su lavelli in composito, lavelli inox, miscelatori, accessori e dissipatori, e dopo l'inserimento di dati e documenti necessari, il Customer Care elaborerà la pratica, fornendoti riscontro entro le 48 ore successive.

Se la pratica rientra in garanzia, essa verrà conclusa nell'arco dei 7 giorni successivi alla data dell'invio della mail con la comunicazione dell'esito della pratica stessa.

PIANI COTTURA | FORNI | CAPPE

In caso di segnalazioni riguardanti gli elettrodomestici (piani cottura, forni e cappe), esse verranno gestite tramite circa 350 centri di assistenza tecnica (CAT) da noi appositamente incaricati. Anche in questo caso, dopo aver fornito i necessari dati e documentazioni, il Customer Care Elleci prenderà contatto con te entro le 48h successive alla segnalazione per definire e concordare le successive tempistiche di uscita e/o di risoluzione pratica.

Mode of technical assistance

SINKS | TAPS | ACCESSORIES | FOODWASTE DISPOSERS

In case of technical assistance on composite sinks, stainless steel sinks, mixers, accessories and foodwaste disposers, and after entering the necessary data and documentation, Customer Care will process the case, providing you with feedback within the next 48 hours. If the case falls under warranty, it will be concluded within 7 days from the date of sending the email notifying the outcome of the case.

HOBBS | OVENS | HOODS

In the case of reports concerning home appliances (cooktops, ovens and hoods), they will be handled through approximately 350 technical assistance centers (CAT) specifically appointed by us. Also in this case, after providing the necessary data and documentation, Elleci Customer Care will contact you within 48h after the reports to define and agree on the subsequent timing of outbound and/or practical resolution.

Un nuovo numero verde a tua disposizione

Un nuovo servizio di assistenza pre e post-vendita

Elleci ha potenziato il suo Customer Care: un vero e proprio team attivo dal lunedì al venerdì dalle 8.30 alle 13.00 e dalle 14.00 alle 17.30, raggiungibile sia da numero fisso sia da smartphone.

Il Customer Care Elleci sarà al tuo rapido servizio per garantire la tua soddisfazione.

A new toll-free number at your disposal

A new pre-sales and after-sales service

Elleci has enhanced its Customer Care: a real team active Monday through Friday from 8:30 a.m. to 1 p.m. and 2 p.m. to 5:30 p.m., reachable by both landline and smartphone.

Elleci Customer Care will be at your quick service to ensure your satisfaction.

NUMERO VERDE / TOLL-FREE NUMBER
800 800 803

Servizio disponibile solo per il territorio italiano

Service available only for the Italian territory

PROJECT COORDINATION

Elleci S.p.a.

CONCEPT AND DESIGN

Mama Studio

PRINTED BY

Sincromia

2024

Elleci S.p.A.

Strada Longitudinale A 1258
Zona industriale Mazzocchio
04014 Pontinia (LT) - Italy

Tel. +39 0773.84.00.36

elleci@elleci.it
www.elleci.com

